

L2502

Upgraded version of the Fairyland



NOTICE OF ASSEMBLE

Tips for Assembling Wood



Find the corresponding block number, use a knife in the connection point gently press, you can take out the wood.

Use a knife to smooth out the burr.

Or use sandpaper to smooth out the burr

Testing on LED function

Be sure to test the LED lights before making the lighting, note that the LED white wire to the negative, gray wire to the positive reference to the following figure operation test.

1



DO NOT contact the LED wire end direct to the battery cell.

2



Use the provide battery holder. Make sue the correct polarity.

How to assemble the battery holder

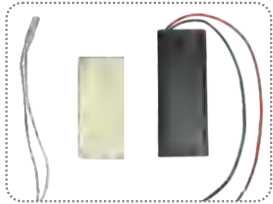

1. Material and tools needed:
- Battery holder, LED bulb, tape, screw driver and 2 pieces AAA size battery(not provided)



2. Use screw driver and take the lid off from the battery holder.

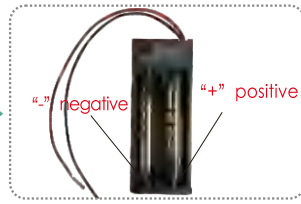

3. Insert the battery take notes on the polarity.

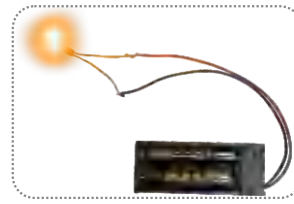

4. Connect the red wire to grey wire. Connect the black wire to white wire.

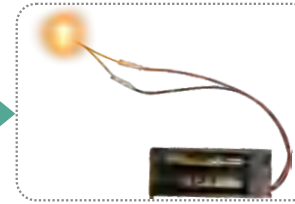

5. Wrap the exposed wire with the tapes.

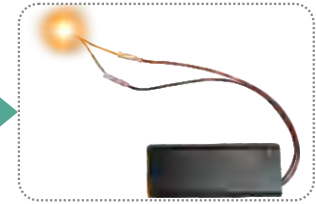

6. Place the box lid and fastness with screw driver.

Symbol description used



Install parts in the opposite direction



Install the same parts on both sides



Pay attention to the direction of installation material B stick to material A



Pay attention to the direction of installation material A stick to material B



Pay attention to the direction of installation material B stick to material A



Pay attention to the direction of installation material A stick to material B



Fold in half according to dotted line



fold double edge to center dotted line



Fold four sides to the middle



Pay attention to the direction of installation material A stick to material B



Pay attention to the direction of installation material B stick to material A



Pay attention to the direction of installation material B stick to material A



Pay attention to the direction of installation material A stick to material B



combination part according to 1 2 3 so on.

About the use of glue

Method for using glue:

1. After applying the glue, let it dry for a few seconds before pasting.
2. Fix it slightly with your hands, and finally put it aside to dry;

Tips:

When pasting the plane printing paper, a piece of waste bank card or telephone card can be used to wipe evenly after the glue is smeared on the wood board, and then the printing paper is pasted to squeeze out the air inside.

Types of glue:

White latex: Used for adhering soft materials, such as wood and paper.
Alcoholic Glue: Used for adhering hard materials such as cloth, plastic, beads, wire, dust cover, etc.

◀ You can tear it down along this line for easy use

L2502 Materials List

unit:cm

Bag
A



A1 MDF
(Wood color)
30*22*0.5cm(1 piece)

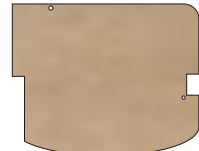

A2 MDF
(Wood color)
23*18.7*0.3cm(1 piece)

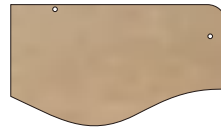

A3 MDF
(Wood color)
23*13*0.3cm(1 piece)



A4 MDF
(Wood color)
22.6*7.9*0.3cm(1 piece)



A5 MDF
(Wood color)
20*9.2*0.3cm(1 piece)

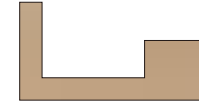

A6 MDF
(Wood color)
20.4*10.5*0.3cm
(1 piece)

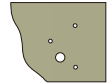

A7 MDF
(Wood color)
10.2*8.5*0.3cm
(1 piece)



A8 MDF
(Wood color)
10.2*8.5*0.3cm
(1 piece)



A9 MDF
(Wood color)
8.5*2.5*0.3cm
(1 piece)



A10 MDF
(Wood color)
8.5*7.8*0.3cm
(1 piece)



A11 MDF
(Wood color)
8.5*4.8*0.3cm
(1 piece)



A12 MDF
(Brown)
31*1.3*0.5cm
(2 pieces)



A13 MDF
(Brown)
22*1.3*0.5cm
(2 pieces)

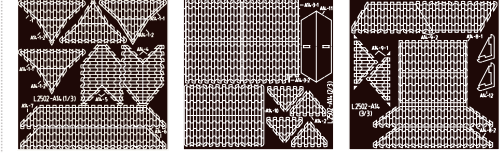

A14 MDF
(Dark brown)
14*14cm(3 pieces)



A15 Simulated water surface
(Transparent)
30*22cm(1 piece)



A16 Simulated water surface
(Transparent)
24*11cm(1 piece)



A17
Printing paper
(Colour)14*14cm
(2 sheets)

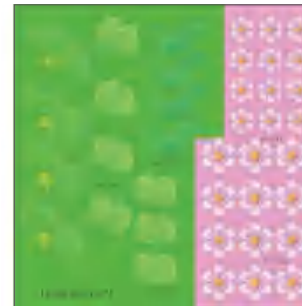

A18
Template paper
(Black and white)
(1 sheet)

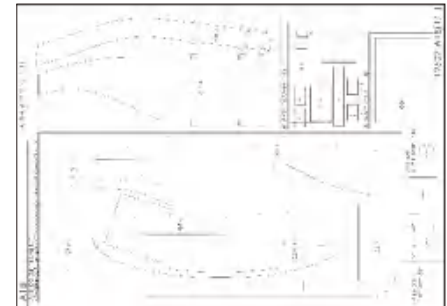

A19 Printing paper(Colour)
(3 sheets)

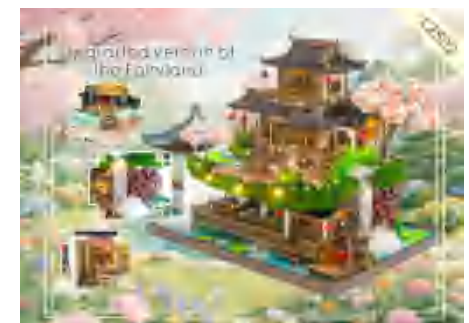









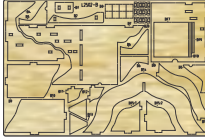
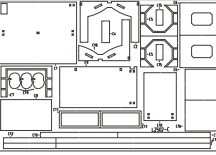
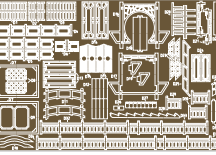
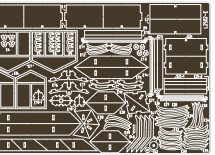
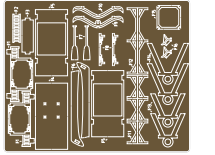
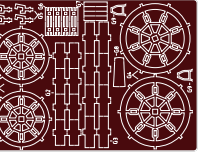
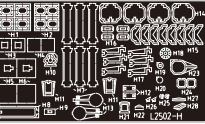
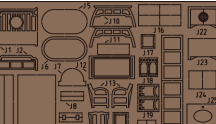

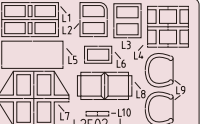
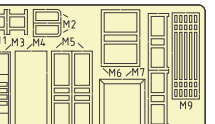
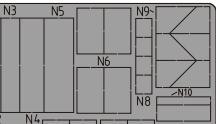
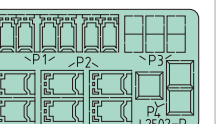

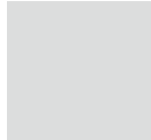







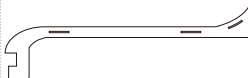

A20
Instruction Manual

◀ You can tear it down along this line for easy use

L2502 Materials List























unit:cm

<p>Bag(B-G)</p>	 <p>Board B Wood particle board(White) 29.6*19.6*0.3cm (1 piece)</p>	 <p>Board C Wood particle board(White) 29.6*19.6*0.2cm (1 piece)</p>	 <p>Board D Wood particle board(Brown) 29.6*19.6*0.2cm (1 piece)</p>	 <p>Board E Wood particle board(Brown) 29.6*19.6*0.2cm (1 piece)</p>	 <p>Board F Wood particle board(brown) 19.6*16*0.2cm (1 piece)</p>	 <p>Board G Wood particle board(Vermilion) 18*13*0.2cm (1 piece)</p>	
<p>Bag(H-P)</p>	 <p>Board H Wood particle board(black) 16*9*0.15cm(1 piece)</p>	 <p>Board J Wood particle board(Dark brown) 15.5*9*0.15cm (1 piece)</p>	 <p>Board K Wood particle board(Apricot color) 9*6.5*0.15cm(1 piece)</p>	 <p>Board L Wood particle board(Light pink) 9*6*0.15cm(1 piece)</p>	 <p>Board M Wood particle board(Light yellow) 10*6*0.15cm(1 piece)</p>	 <p>Board N Wood particle board(Light grey) 9*5*0.15cm(1 piece)</p>	 <p>Board P Wood particle board(Peppermint green) 7*4*0.15cm(1 piece)</p>
<p>Bag Q</p>	 <p>Q1 Silk cloth (white) 10*7cm(1 piece)</p>	 <p>Q2 Linen (Coffee color) 9*5cm(1 piece)</p>	 <p>Q3 Hard cardboard (white)10*10cm (1 piece)</p>	 <p>Q4 Mirror paper (Silver) 1.6*1.4cm(1 piece)</p>	 <p>Q5 Turf(green) 34*16cm(1 piece)</p>	 <p>Q6 line(Gold) 35cm(1 strip)</p>	 <p>Q7 Fine iron wire (black)12cm (1 strip)</p>
 <p>Q8 Fine iron wire (black)8cm (1 strip)</p>	 <p>Q9 Iron wire (Gold)2cm (1strip)</p>	 <p>Q10 Cotton (white) (some)</p>	 <p>Q11 Toothpick (Wood color) (1 strip)</p>	 <p>Q12 Round wood (white) Φ=0.4*1.2cm(3 strips)</p>	 <p>Q13 Organic glass (Transparent) 8.8*2.8*0.3(4 pieces)</p>		
<p>Bag R</p>	 <p>R1 Small rubber beads(Gold) (18 pieces)</p>	 <p>R2 Square rubber beads(Transparent) (2 pieces)</p>	 <p>R3 Small rubber beads(black) (5 pieces)</p>	 <p>R4 Small rubber beads(red) (6 pieces)</p>	 <p>R5 Small rubber beads(green) (3 pieces)</p>	 <p>R6 Small rubber beads(orange) (3 pieces)</p>	 <p>R7 Flower bed (Gold) (1 piece)</p>

◀ You can tear it down along this line for easy use

L2502 Materials List

unit:cm

 <p>R8 Cylindrical rubber beads (Khaki color) (3 pieces)</p>	 <p>R10 Flower bed (blue) (10 pieces)</p>	 <p>R11 Metal small flower tray(Gold) (5 pieces)</p>	 <p>R12 Metal flower tray(Gold) (17 pieces)</p>	 <p>R13 Iron bead (Gold) (1 piece)</p>	 <p>R14 Log beads (red) (8 pieces)</p>	 <p>R15 Wooden beads (Wood color) (2 pieces)</p>	 <p>R16 Flat rubber beads(white) (2 piece)</p>
Bag S	 <p>S1 Big cherry blossom tree(Pink) (1 tree)</p>	 <p>S2 Little cherry blossom tree(Pink) (1 tree)</p>	 <p>S3 Bamboo (green) (2 trees)</p>	 <p>S4 Plastic plants (green) (3 trees)</p>	 <p>S5 Plastic lotus leaf (green) (3 pieces)</p>	 <p>S6 Stone lion (Grey) (1 piece)</p>	 <p>S7 Stone lion (Grey) (1 piece)</p>
 <p>S8 Resin stone (Grey) (1 piece)</p>	 <p>S9 Resin toilet (white) (1 piece)</p>	 <p>S10 Stone (white) (some)</p>	 <p>S11 Broken stones (Apricot color) (some)</p>				
Bag U	 <p>U1 LED lamp (Warm light) (13 strips)</p> <p>Before using the Led light, please test whether it can light up</p>	 <p>U2 AAA battery box (black)(1 piece)</p>	 <p>U3 Sand paper (white) (2 sheets)</p>	 <p>U4 Tape (black) (1 sheet)</p>			

◀ You can tear it down along this line for easy use

Waterwheel

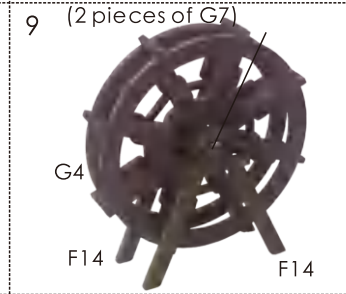
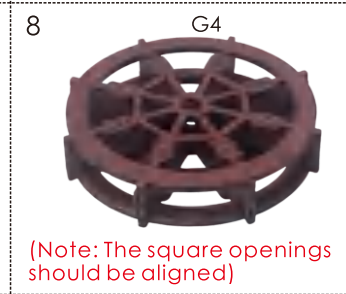
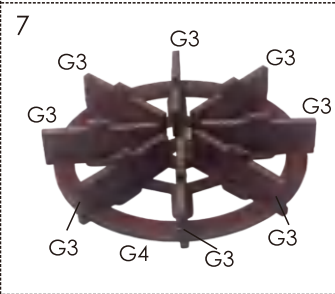
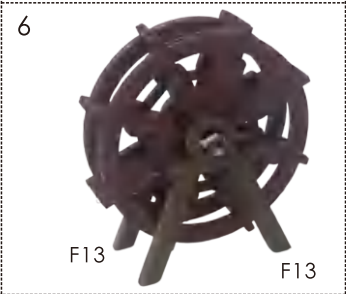
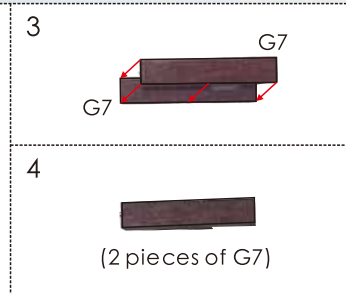
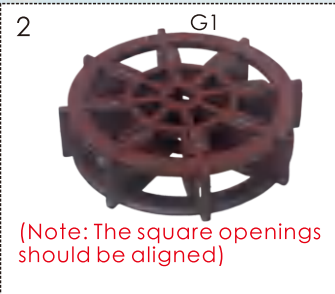
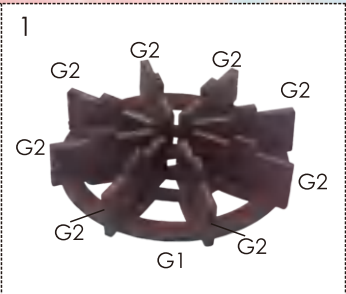
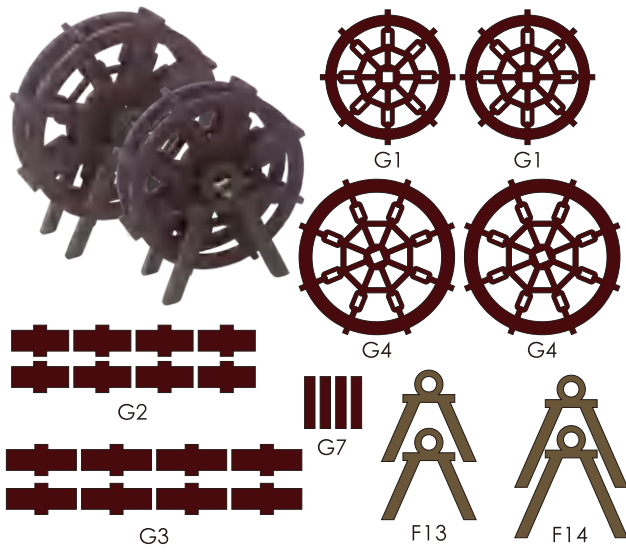

Little bridge

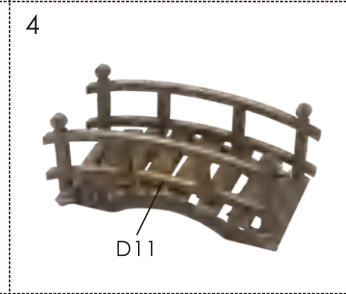
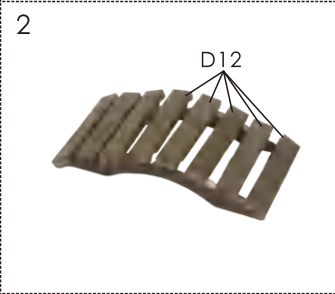
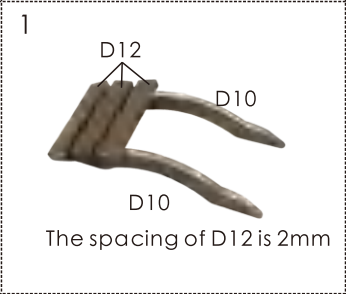
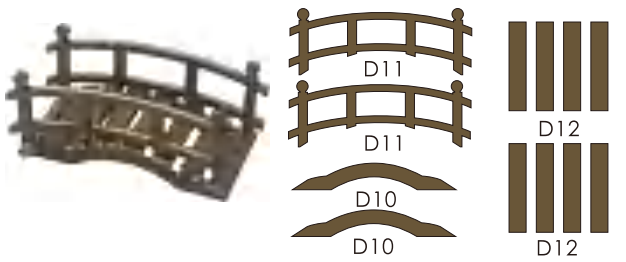

Guzheng and pipa

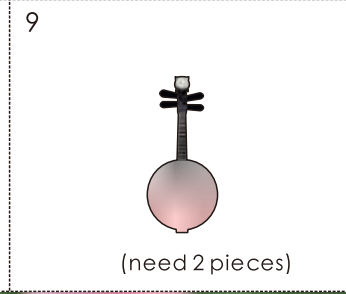
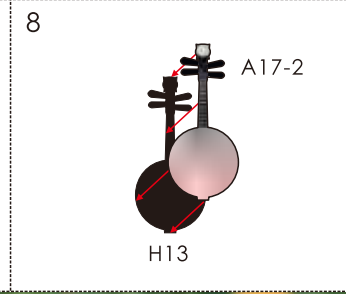
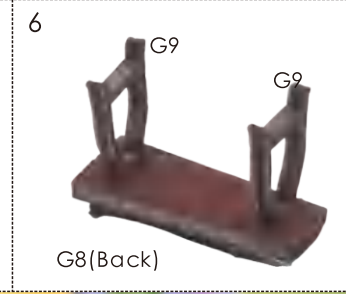
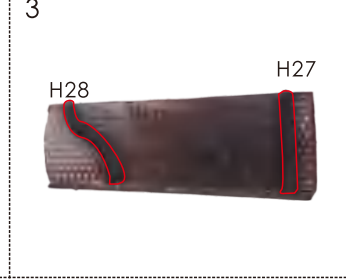
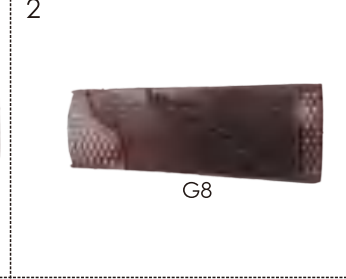
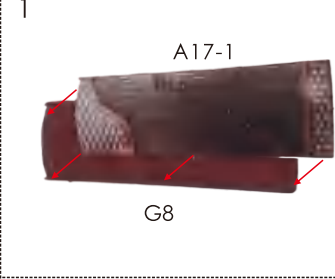
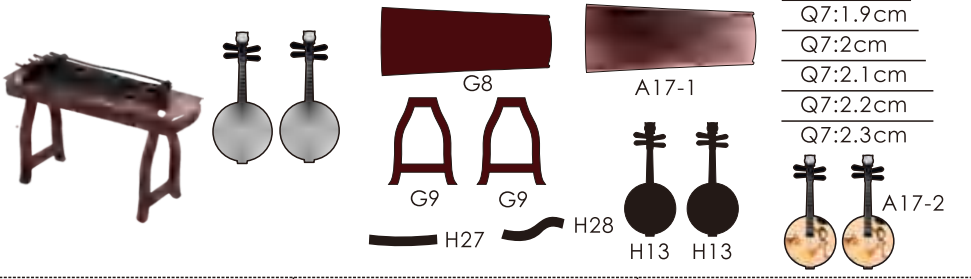



U1

Before using the Led light, please test whether it can light up

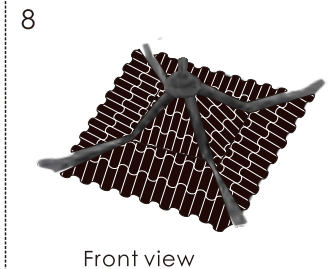
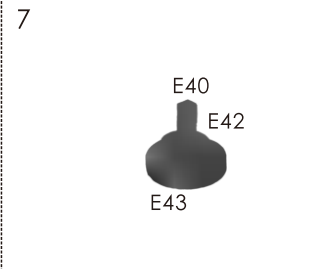
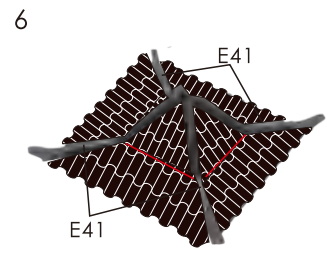
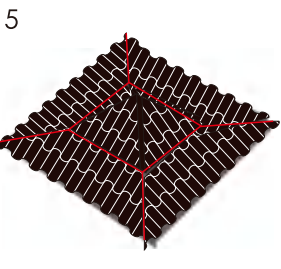
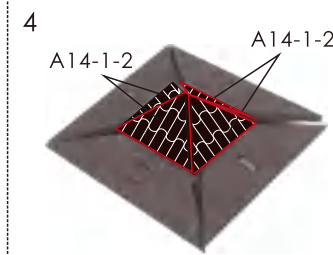
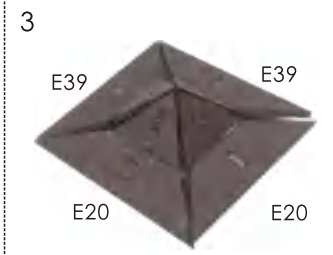
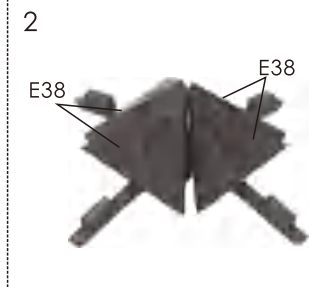
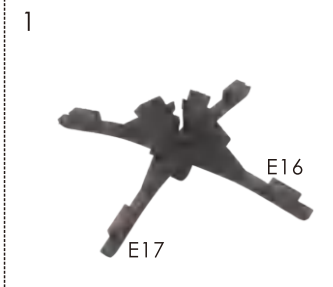
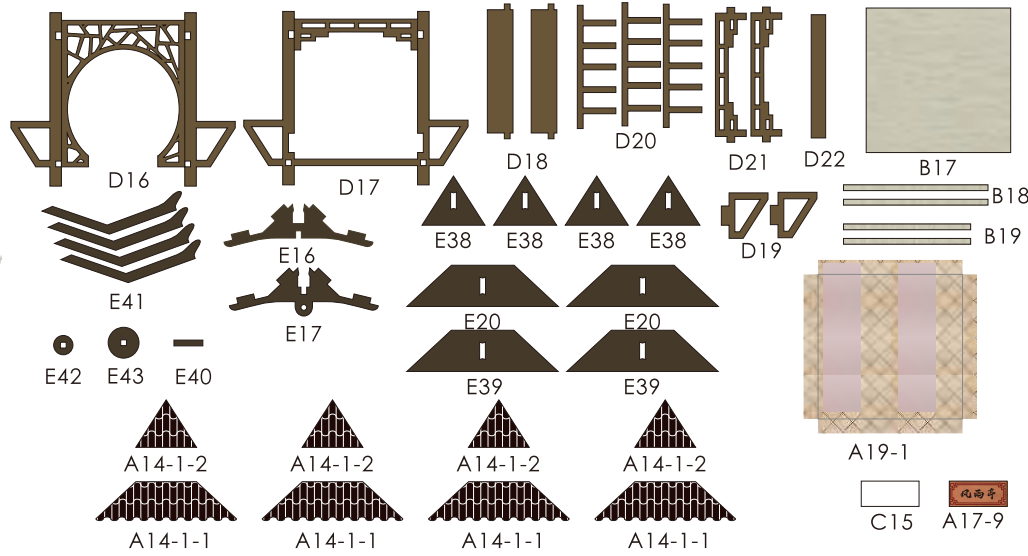

Front view



Bottom view

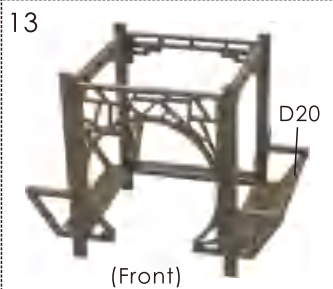
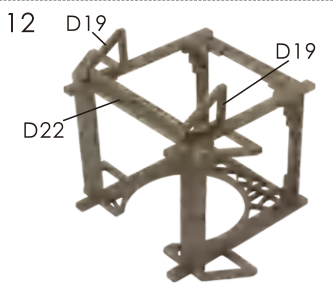
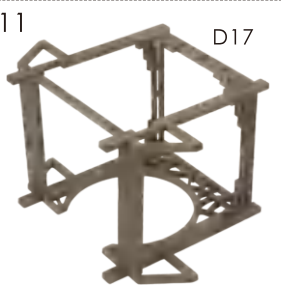
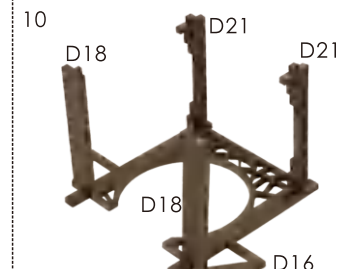

(Front)

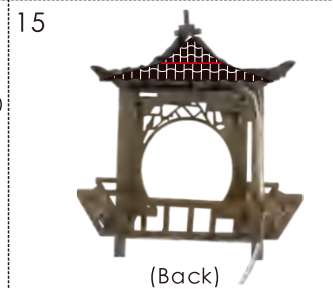
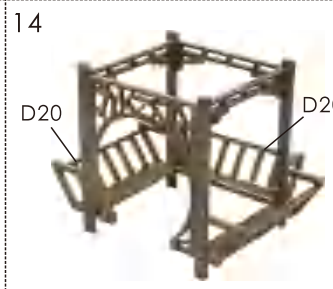

(Back)

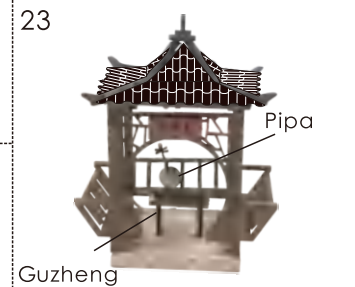
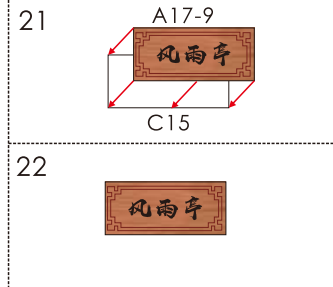
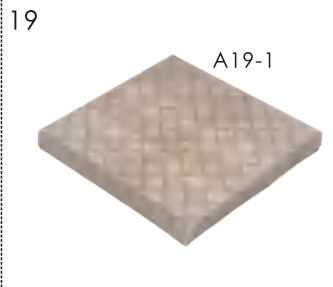
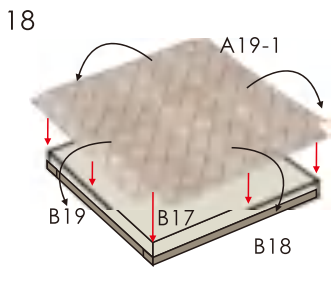
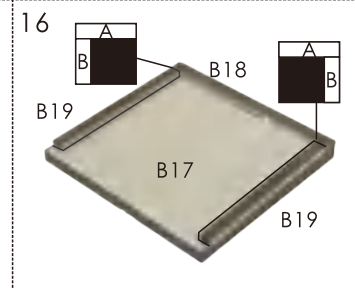

Pipa

Guzheng

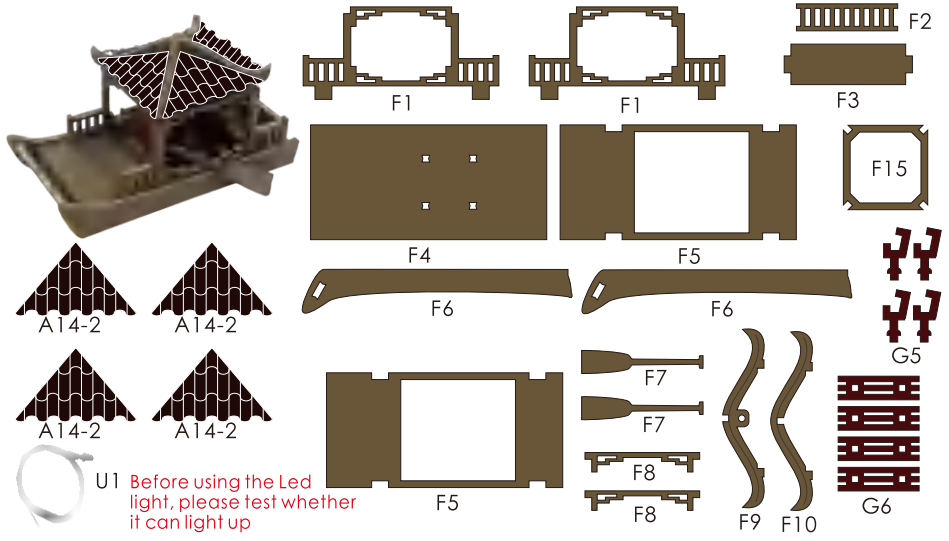

U1 Before using the Led light, please test whether it can light up

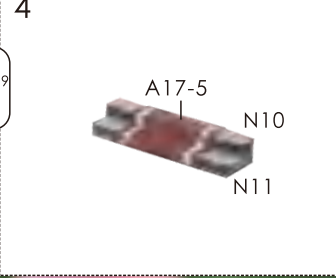
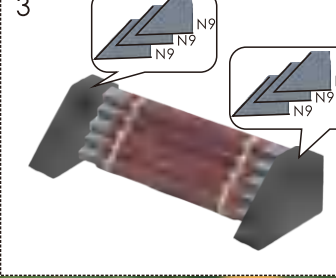
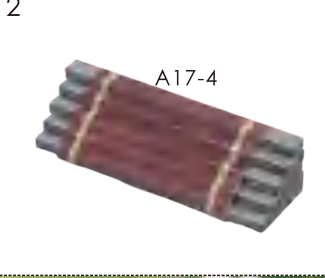
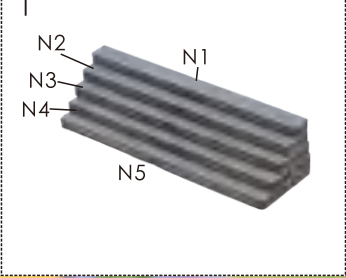
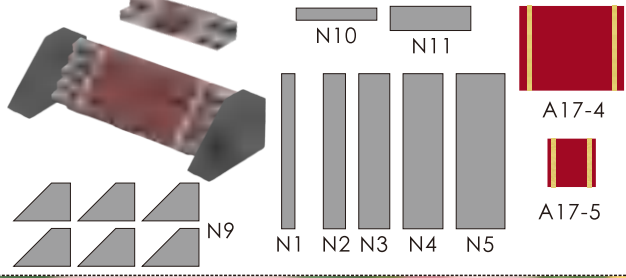
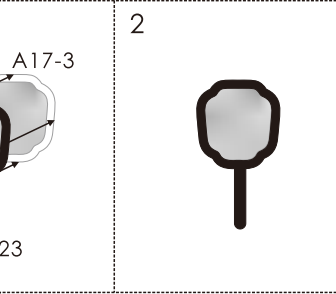
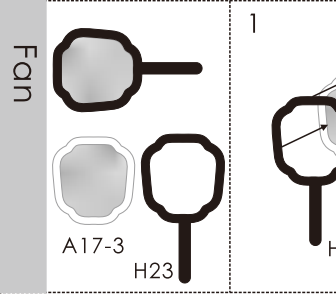
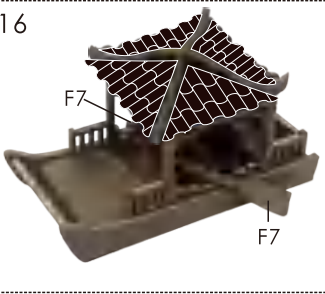
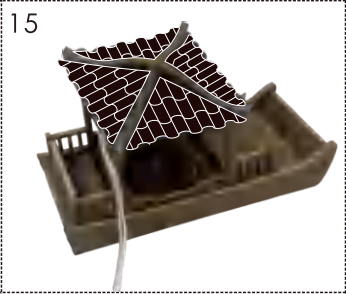
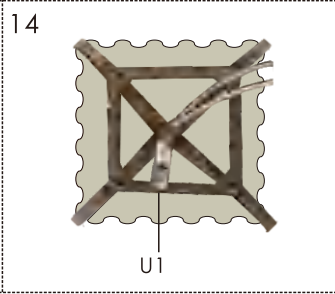
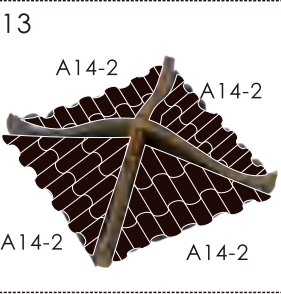
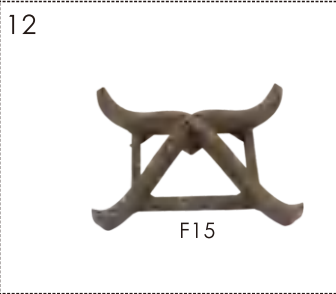
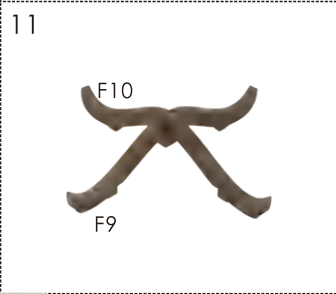
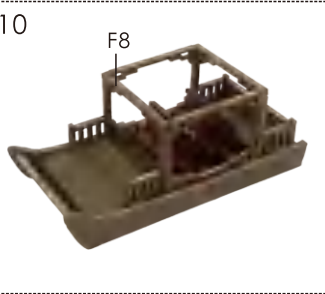
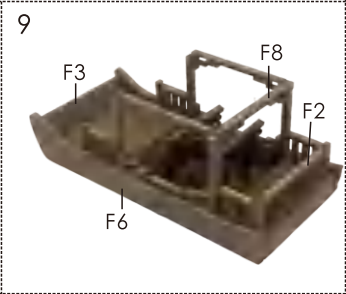
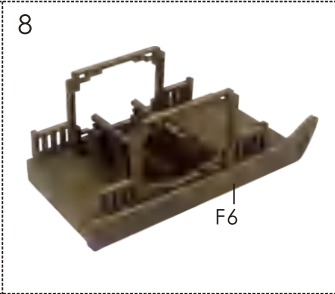
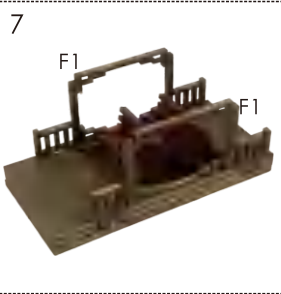

Outdoor lamp

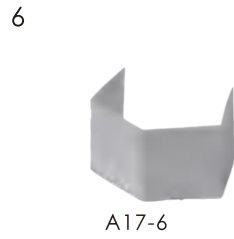
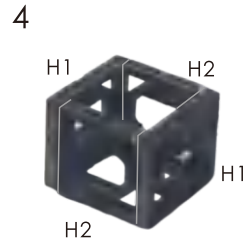
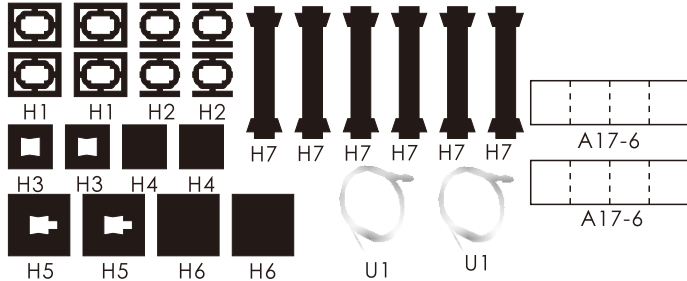

Small chandelier

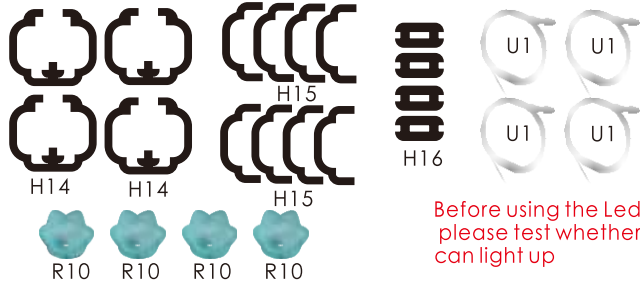

Before using the Led light, please test whether it can light up

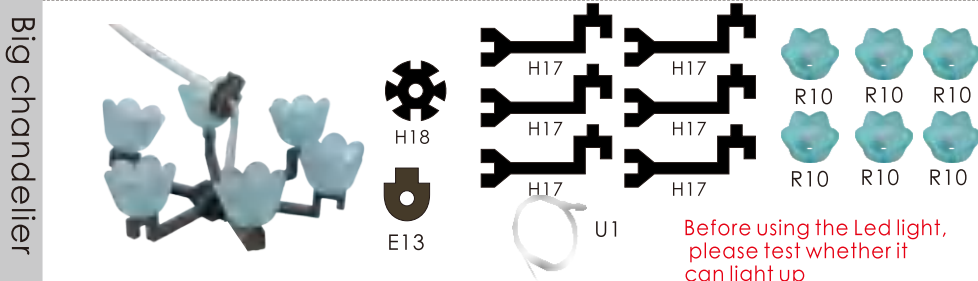
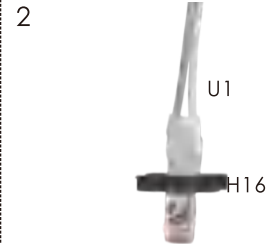
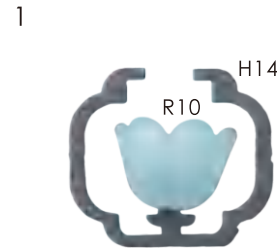

Before using the Led light, please test whether it can light up

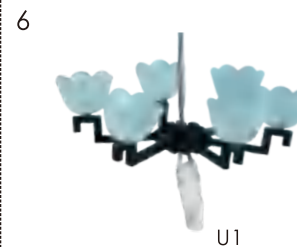
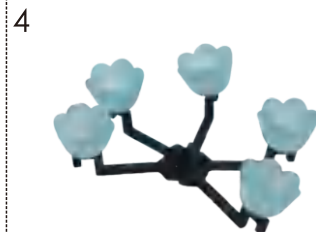
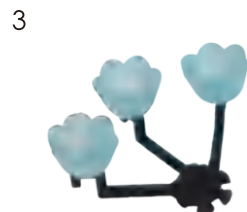
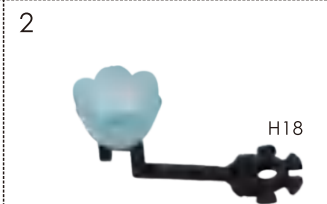
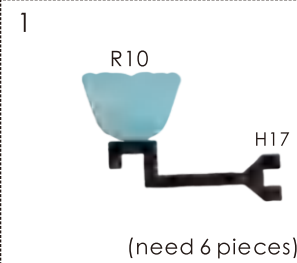

Stone lion

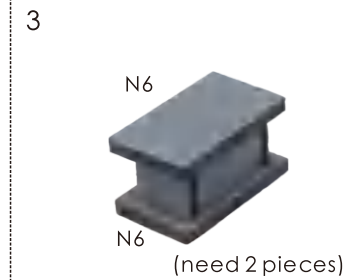
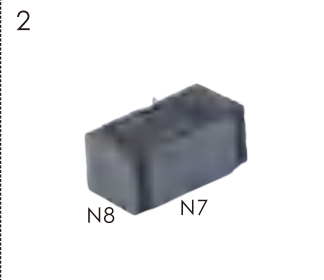
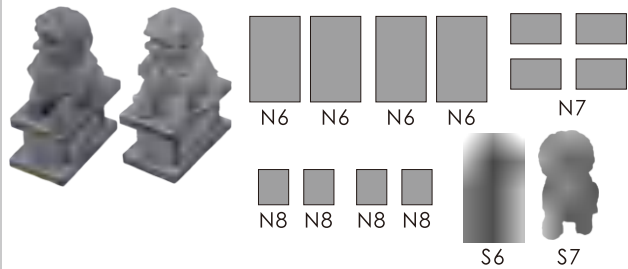

Side table

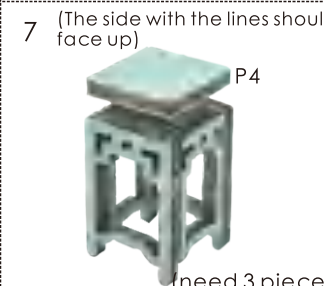
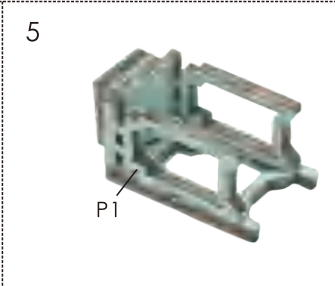
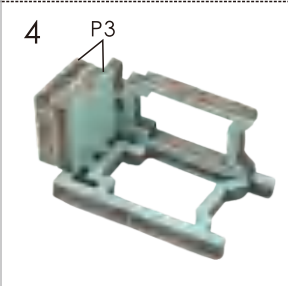
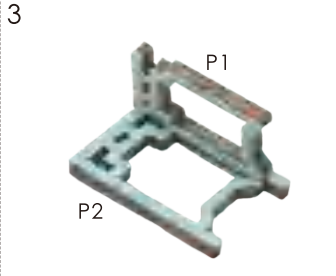
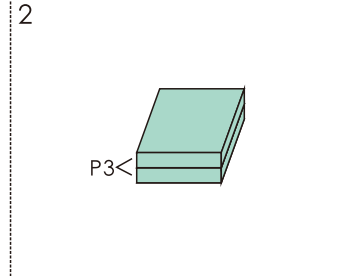
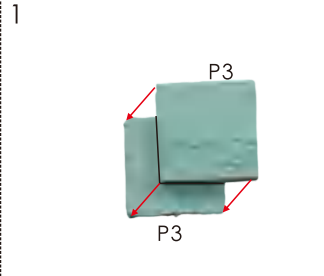
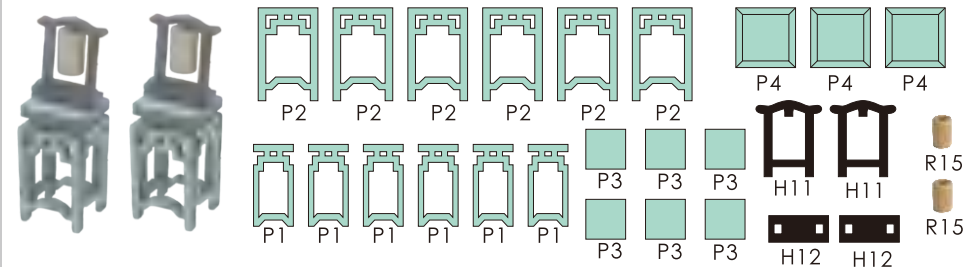

Chair

Before making, cut out Q1 and Q3 according to the template

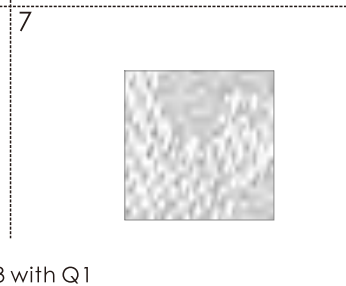
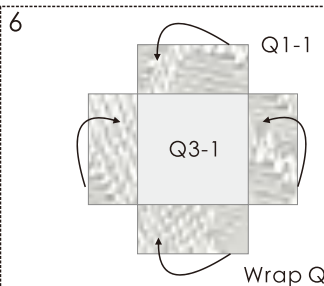
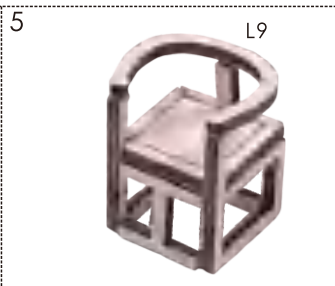
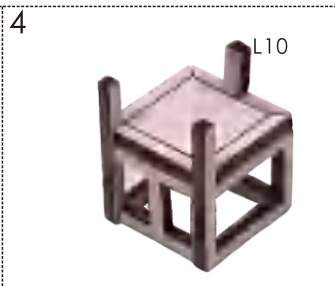
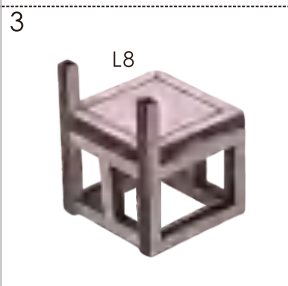
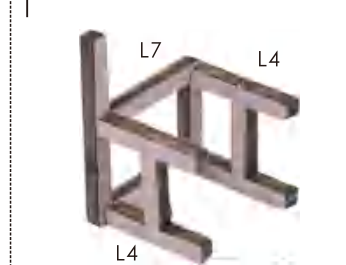
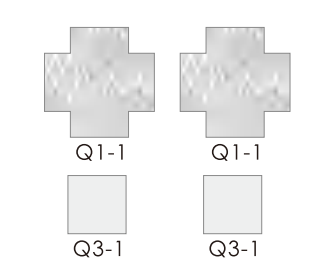
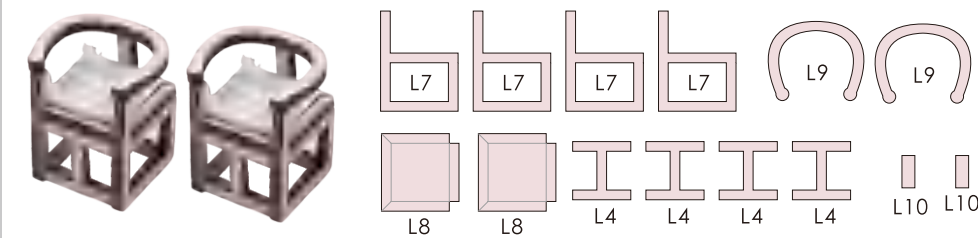

Wrap Q3 with Q1

Lounge chair

Before making, cut out Q1 and Q3 according to the template

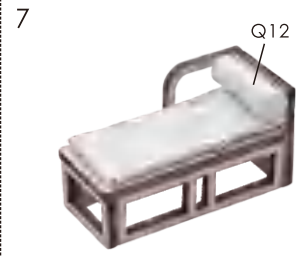
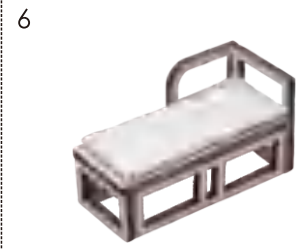
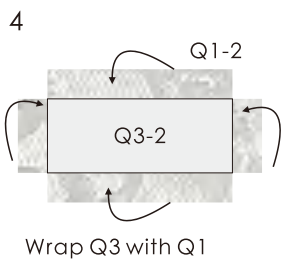
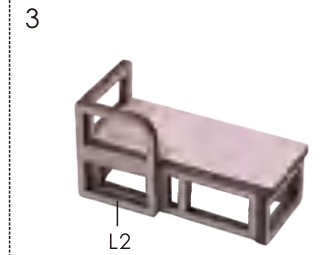
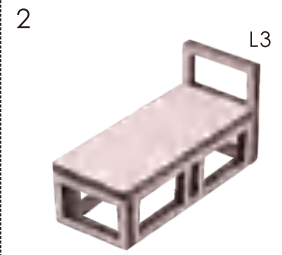
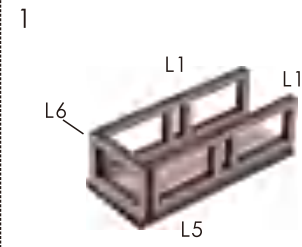
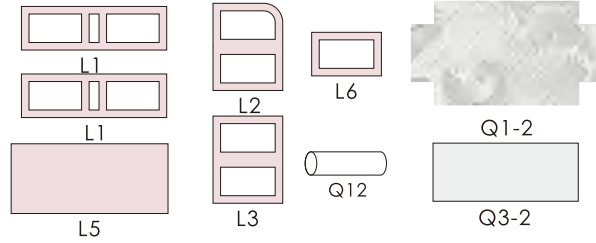

Bench

Before making, cut out Q1 and Q3 according to the template

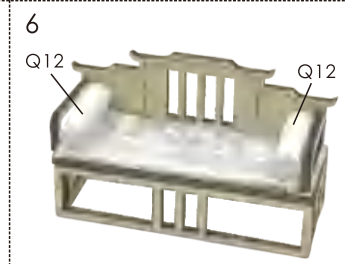
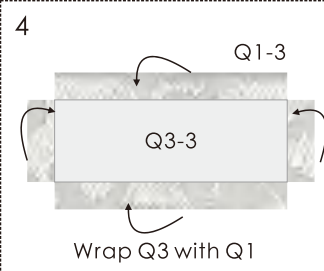
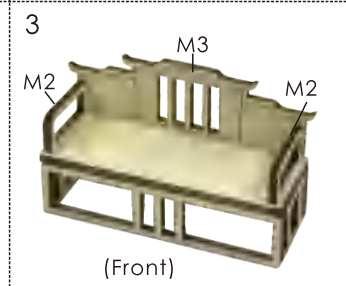
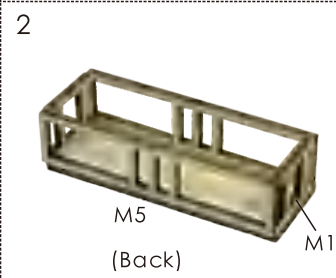
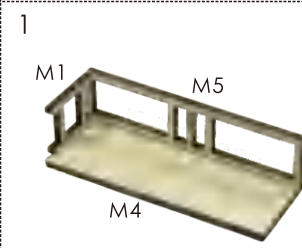
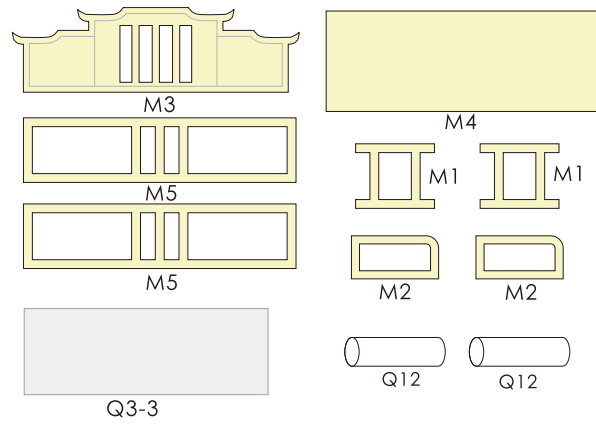

Tea table

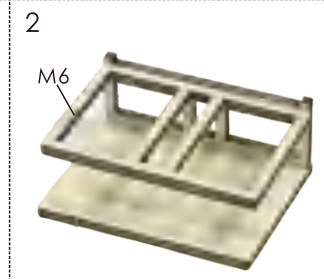
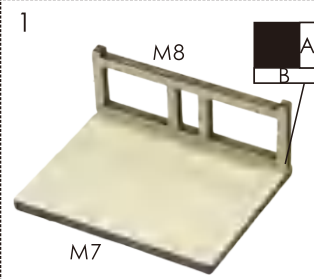
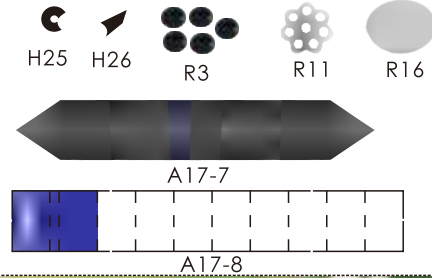
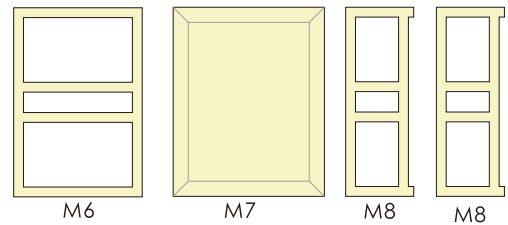

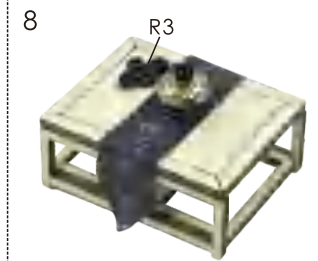
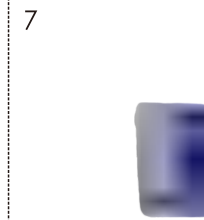
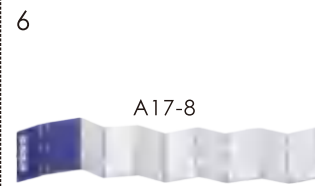
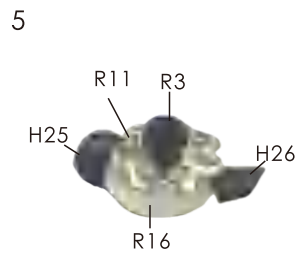
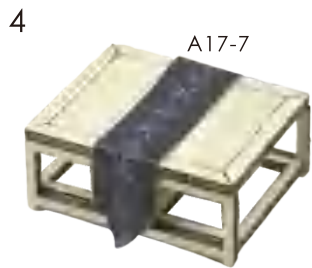
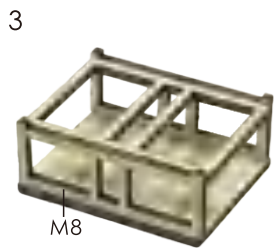

Dining table and chairs

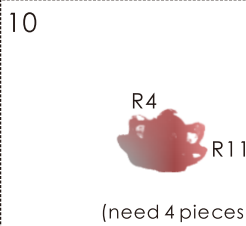
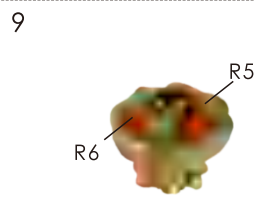
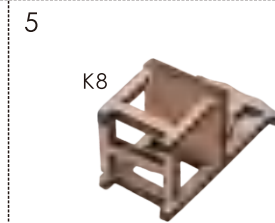
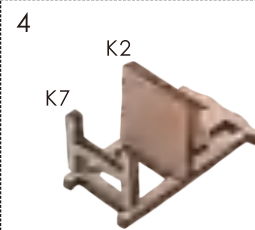
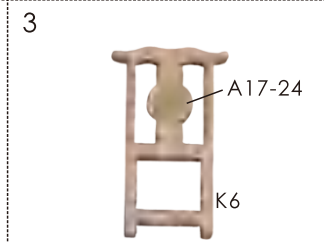
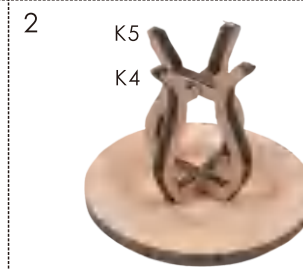
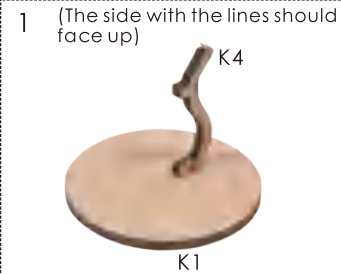
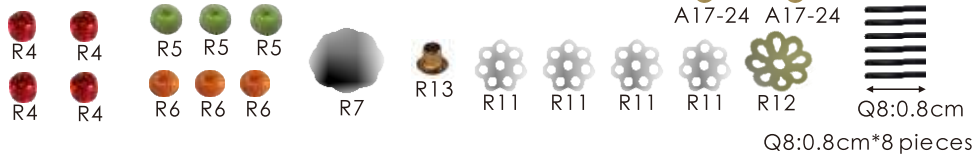
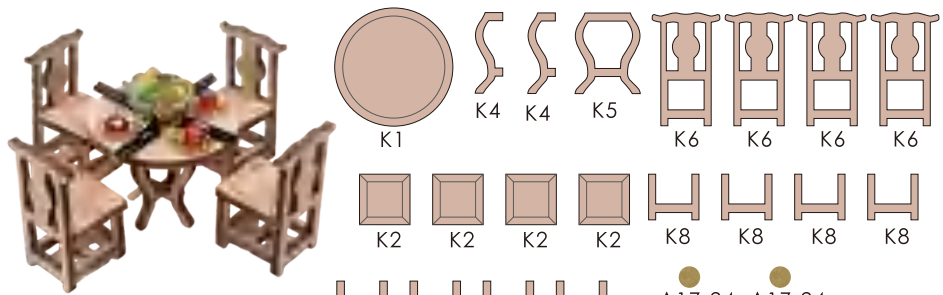

Bedside table

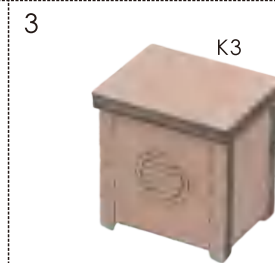
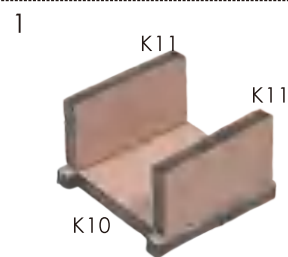
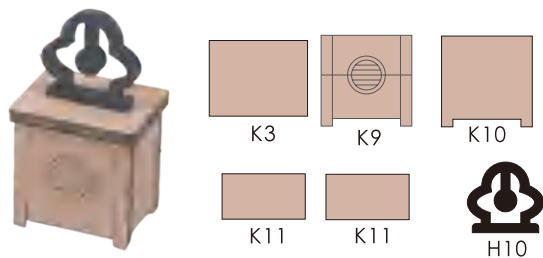

Before making, cut out Q1 and Q3 according to the template

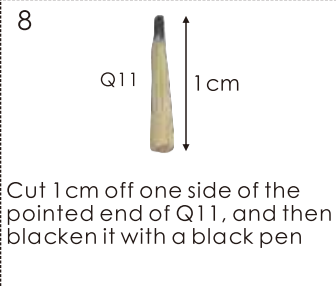
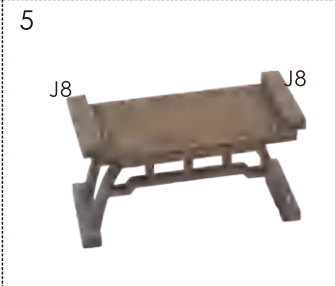
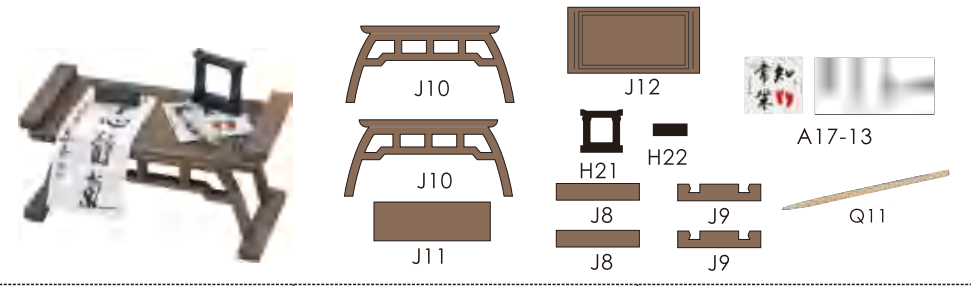
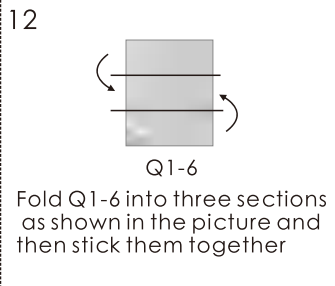
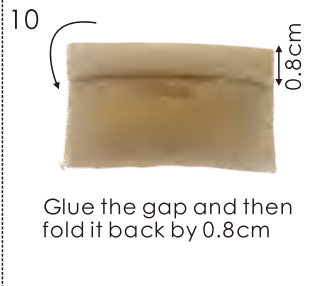
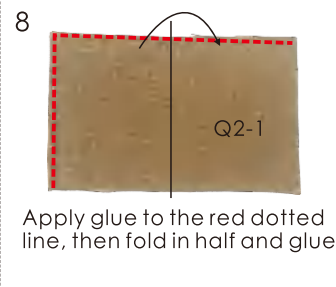
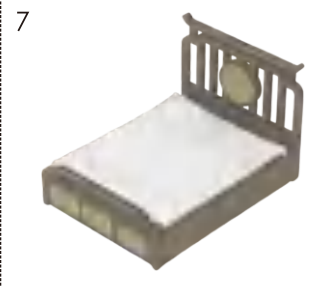
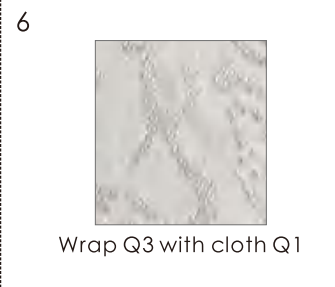
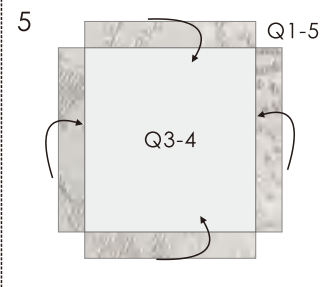
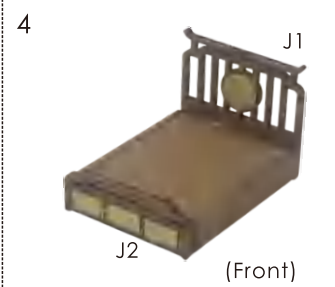
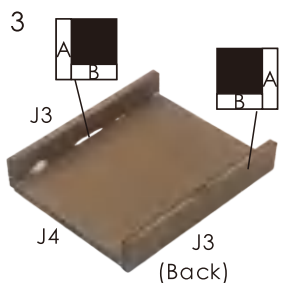
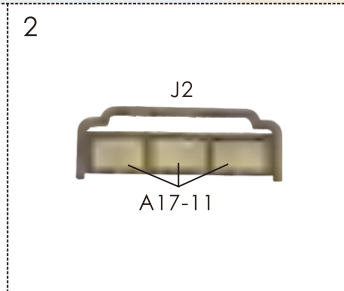
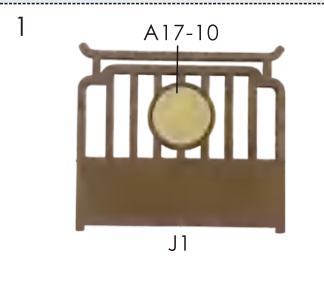
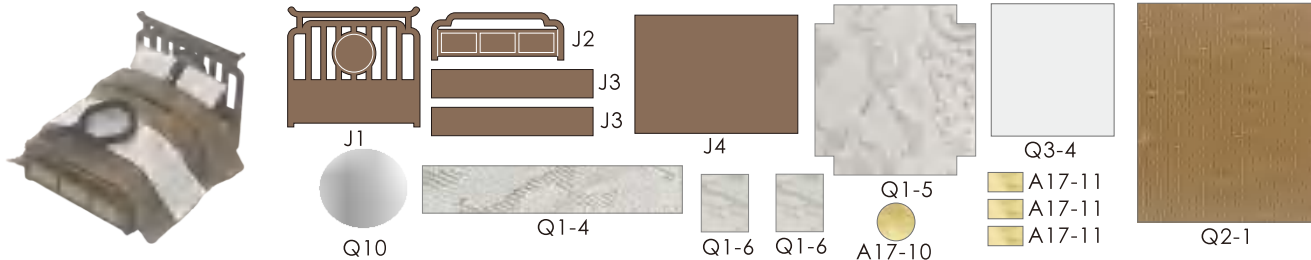

Chair

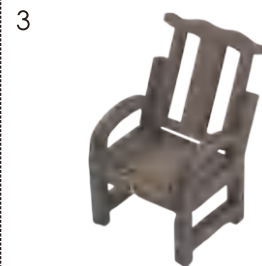
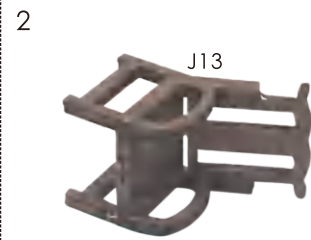
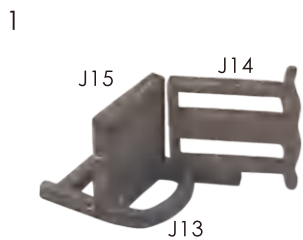
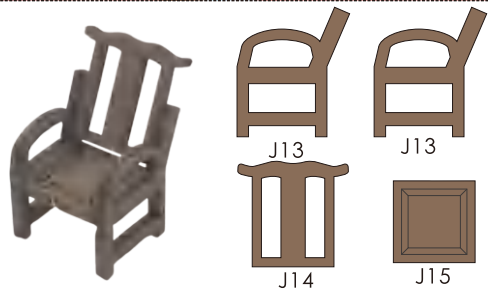

Bookshelf

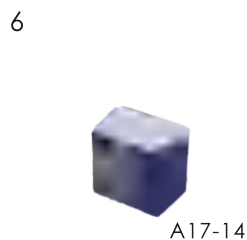
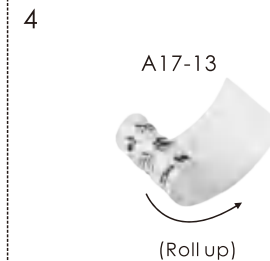
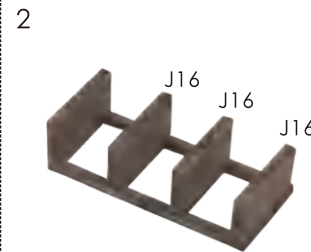
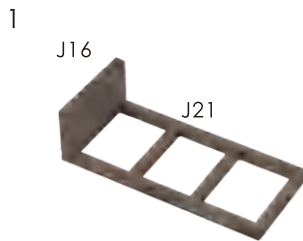
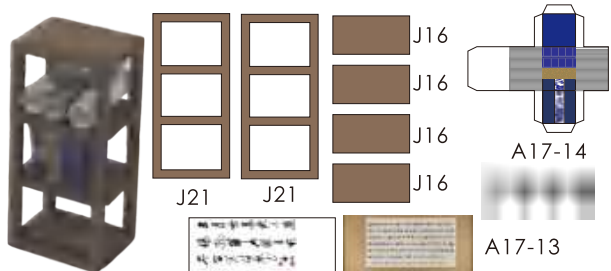

Potted plant

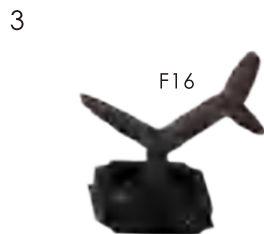
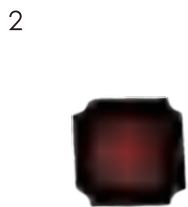
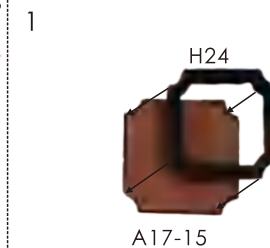
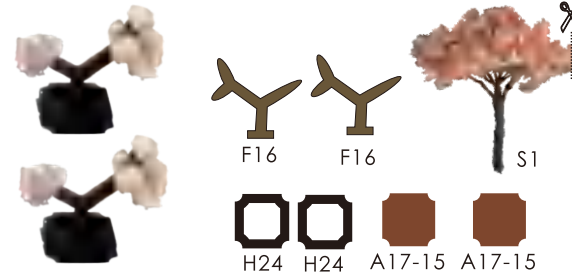

Side table

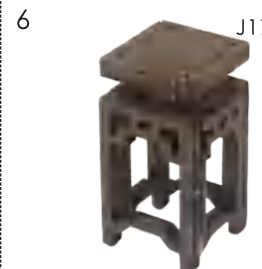
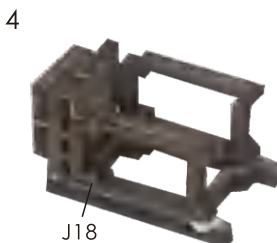
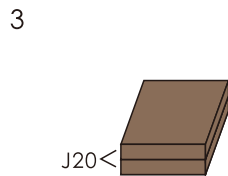
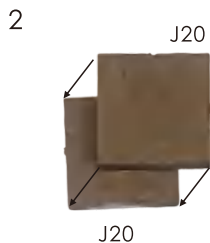
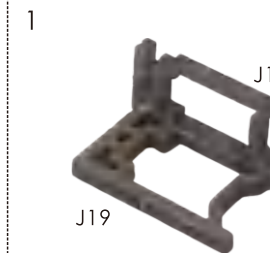
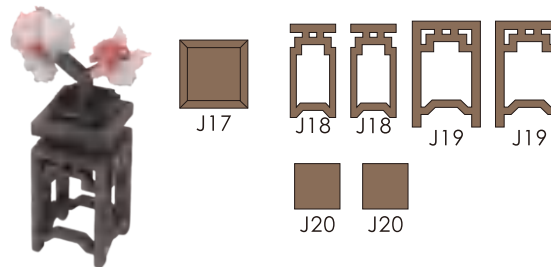

Bathub

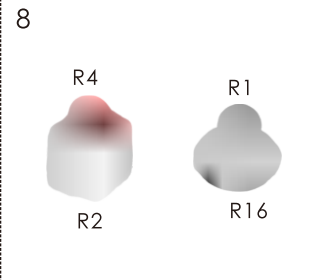
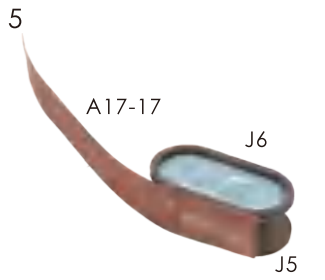
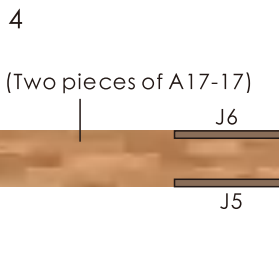
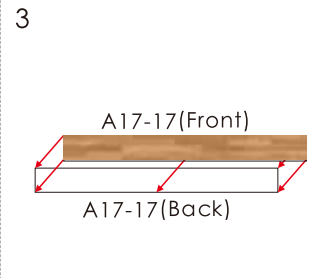
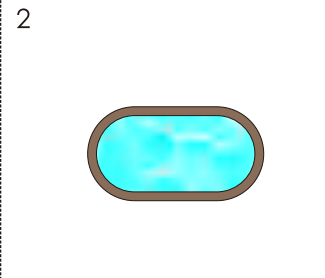
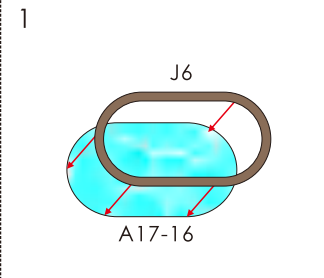
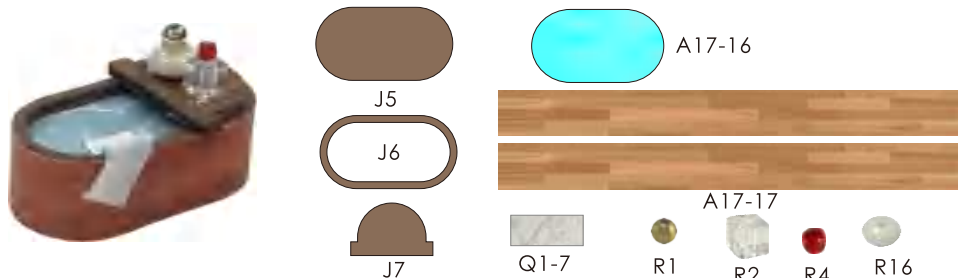

Washbasin

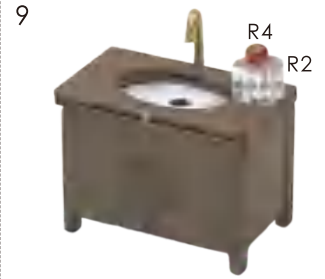
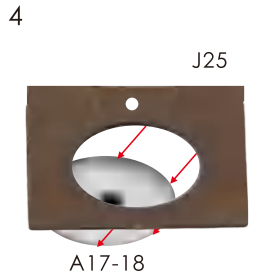
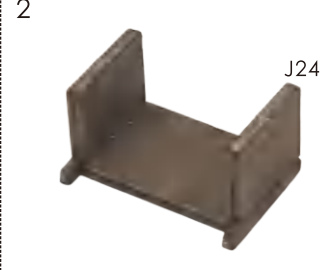
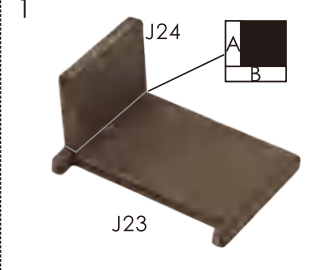
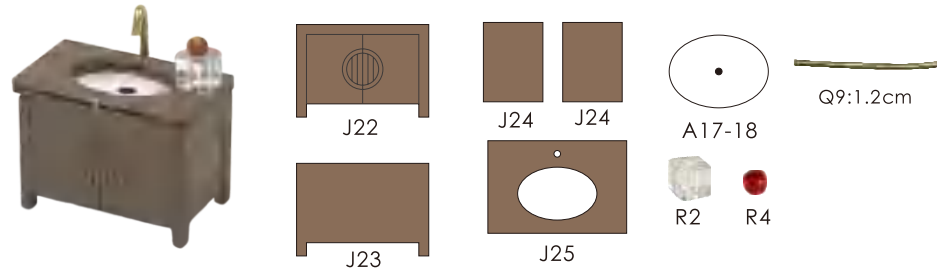

Floor lamp

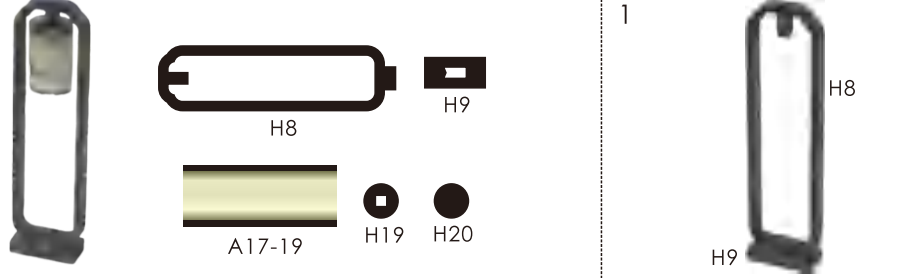

Lantern

1. R14(8 pieces), R1(16 pieces), R12(16 pieces), Q6:3.5cm*8 strips

1. Tie a knot at the position shown in the picture (0.8cm)

2. R1

3. R12

4. R14

5. R12

6. R1 (need 8 pieces)

Outer frame

1. A19-2, A5

2. A5(Front)

3. A5(Back), C17, A, B

4. C14

5. C12, A, B

6. C12, A, B

7. C14

8. C13

10. A19-3 (Front), Wrap the edges with A19-3

11. (Front)

12. E7

13. A19-4, C16 (Note: Stick to the wood-colored surface)

14. C16

15. C16

16. Plant S4, Cut out S4

17. Plant S4, R8 (need 3 pieces)

18. Plant

19. Chairs

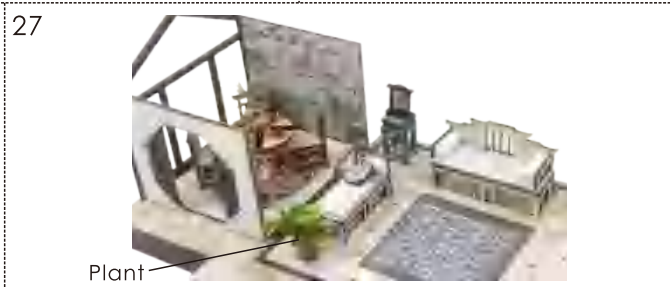
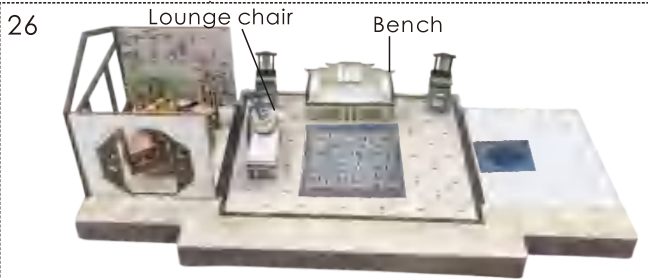
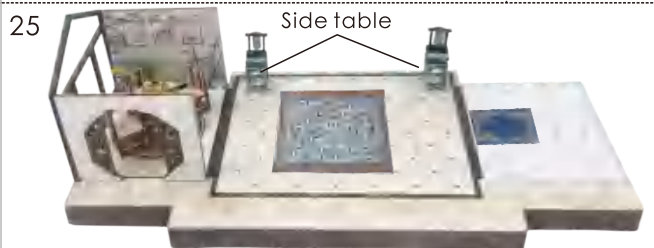
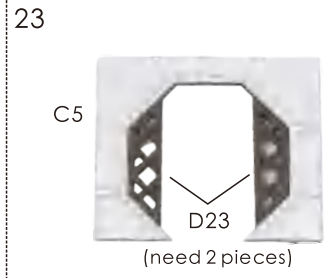
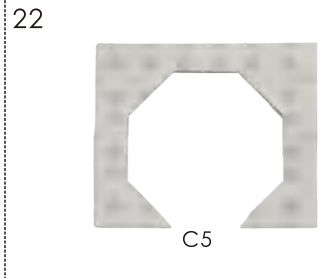
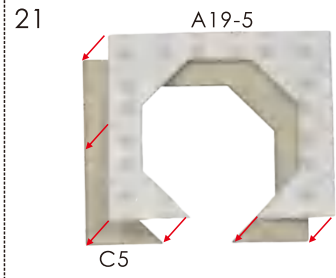

The placement of furniture should refer to the markings on the printed paper

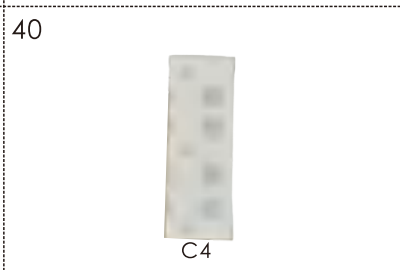
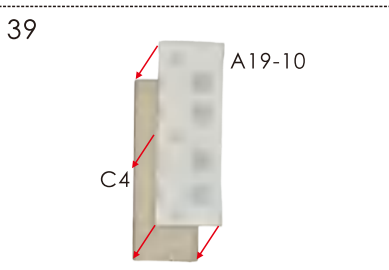
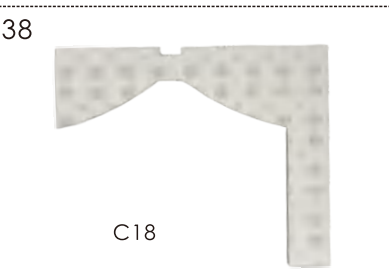
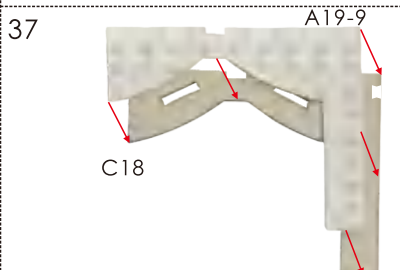
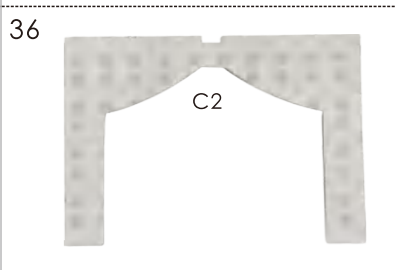
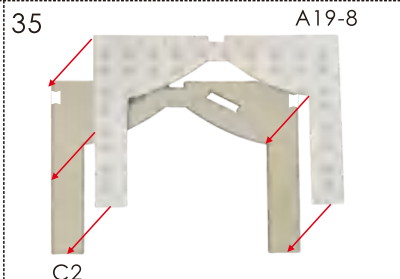
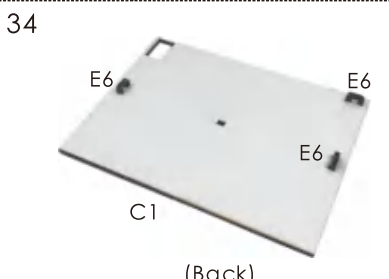
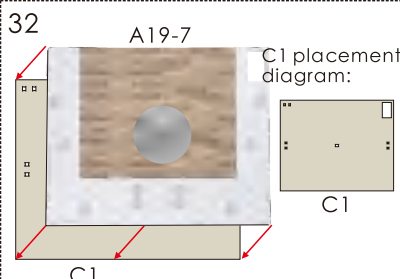
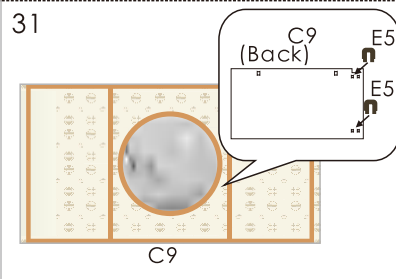
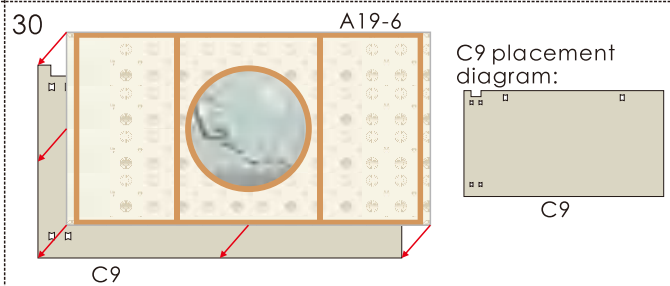

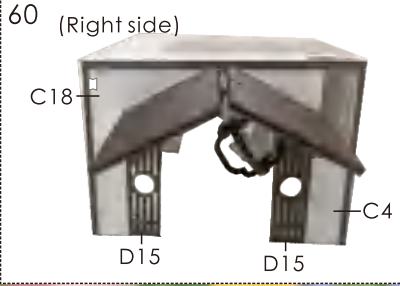
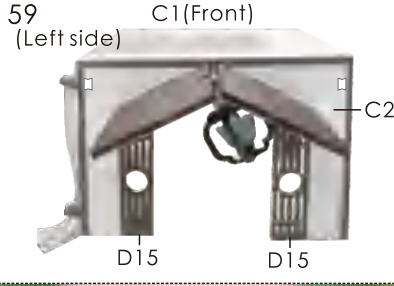
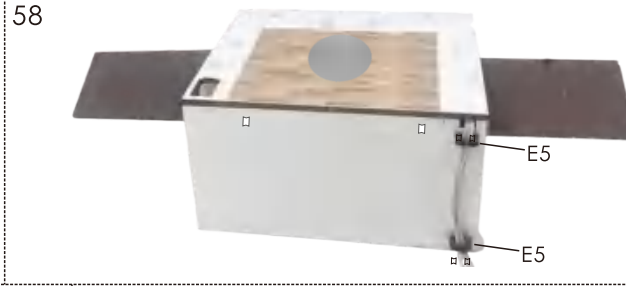
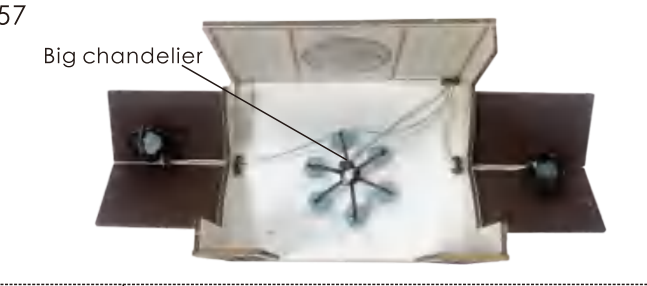
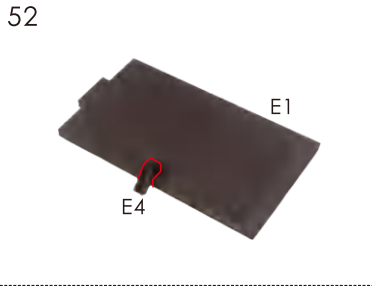
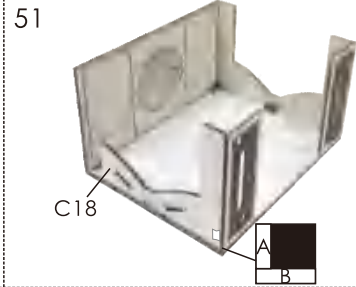
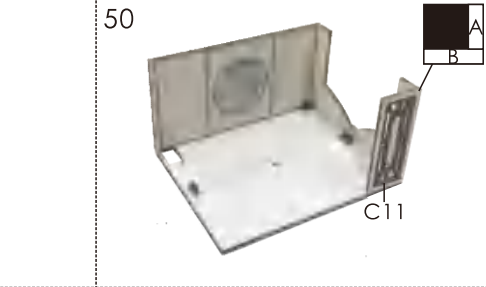
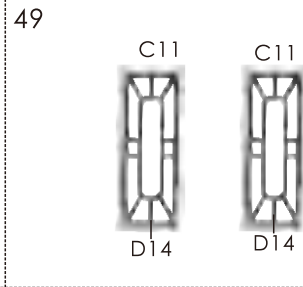
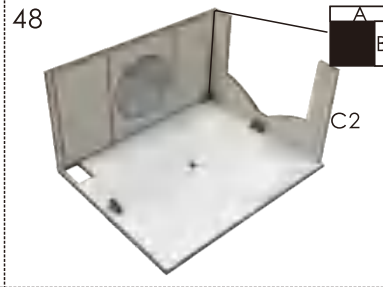
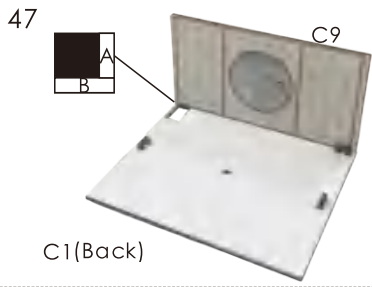
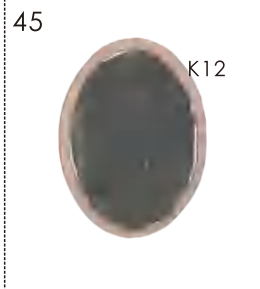
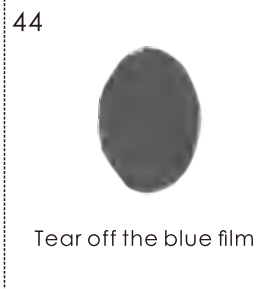
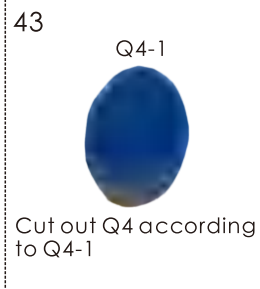
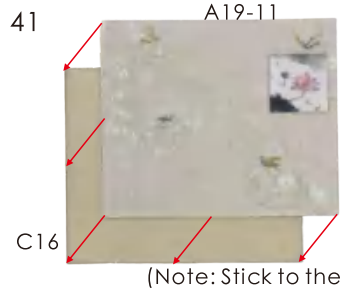

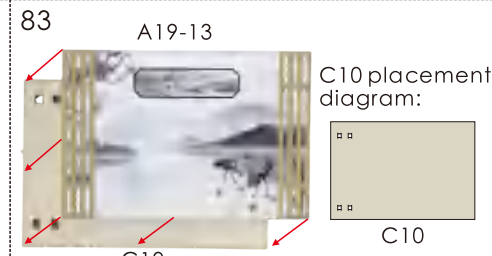
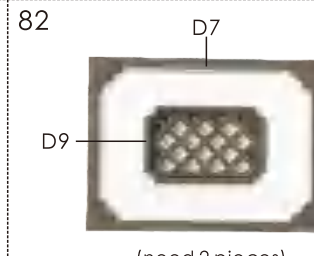
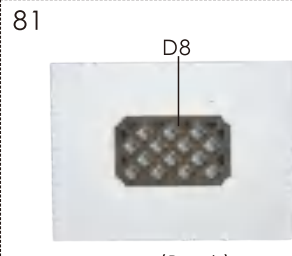
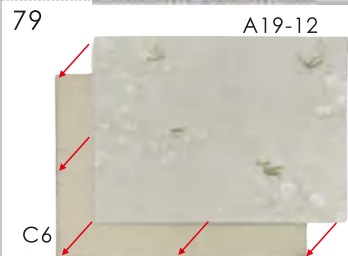

84



C10(Front)

85



C10(Back)

86

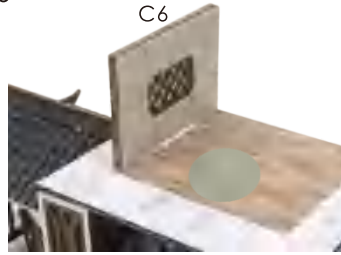

C6

87

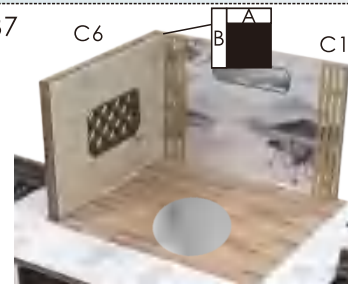

C6

C10

88

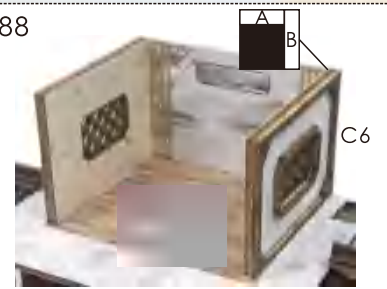

C6

89

Bedside table



Bed

90

Floor lamp



91



Plant

92



93



D28

D26

94

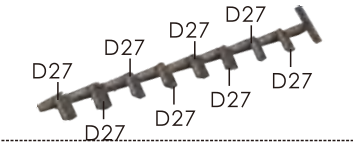

D27

D27

D27

D27

D27

D27

95

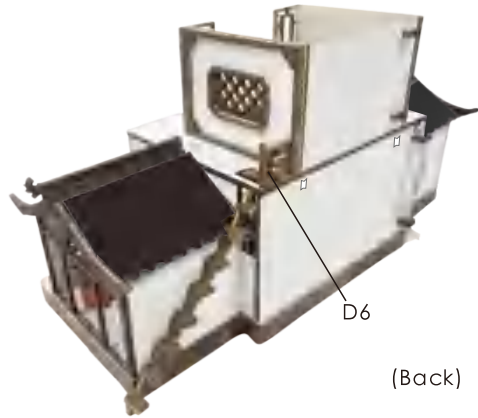

D6

(Back)

96

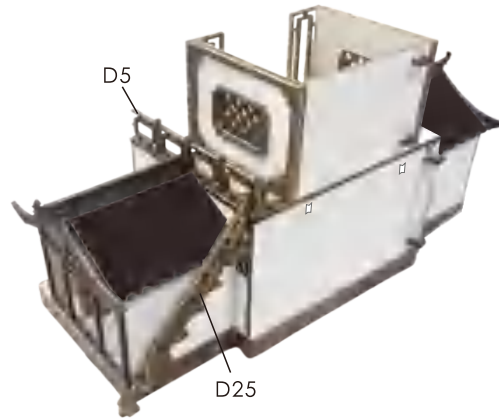

D5

D25

97

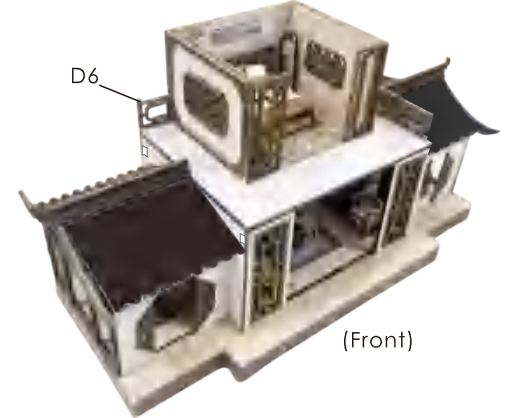

D6

(Front)

98

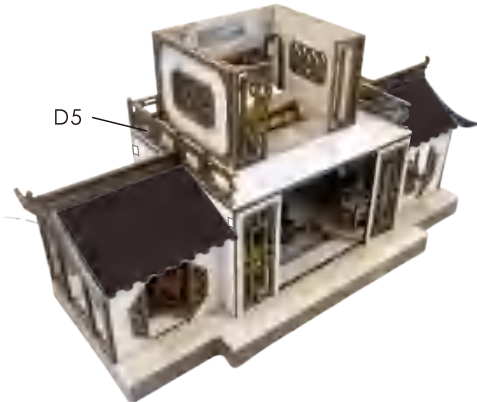

D5

99

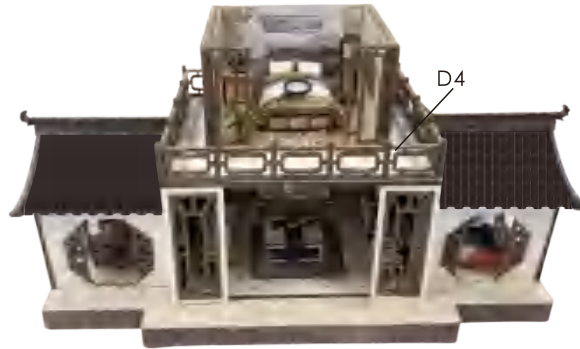

D4

100



D2

101

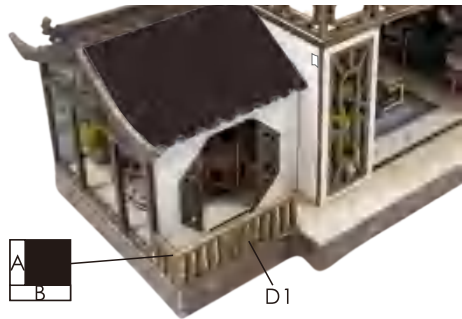

102

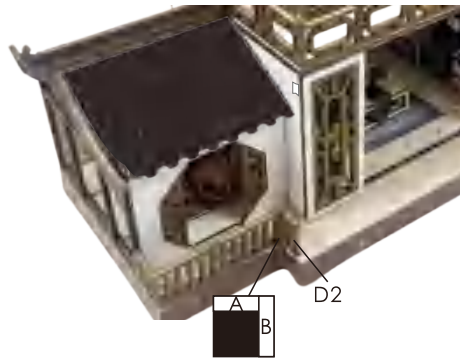

103

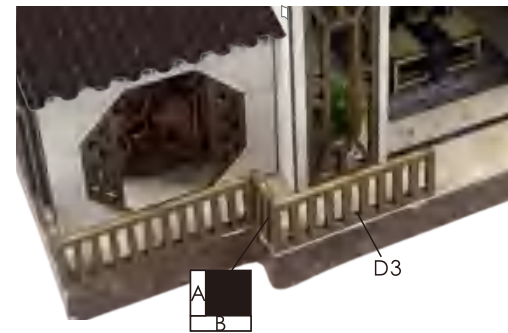

104

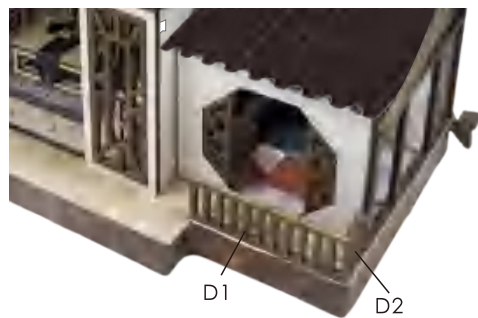

105



106



107

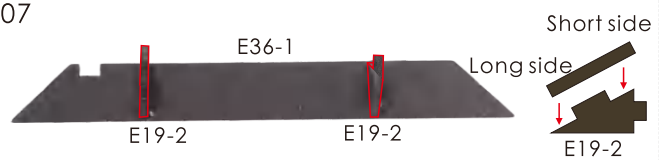

109

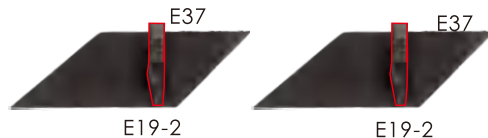

111

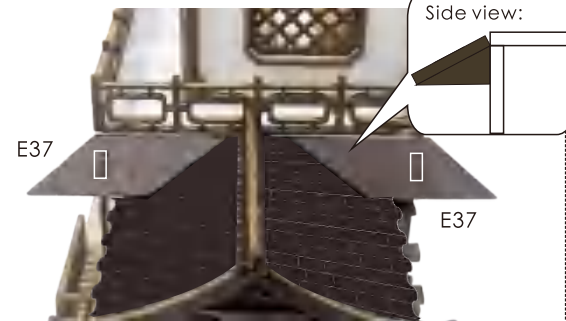

108



110



112

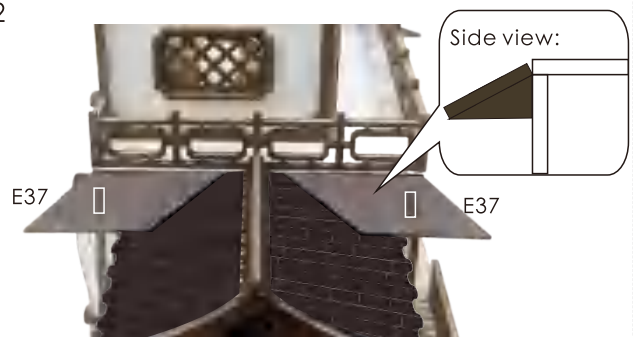

113



114



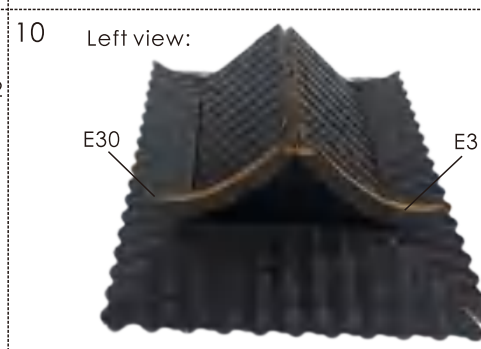
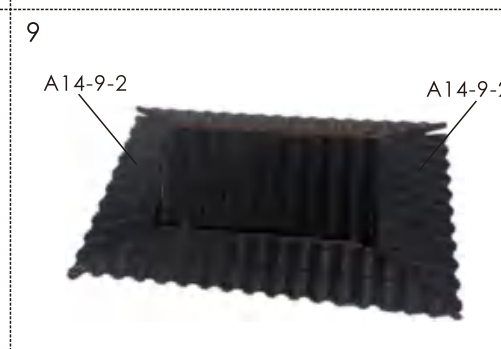
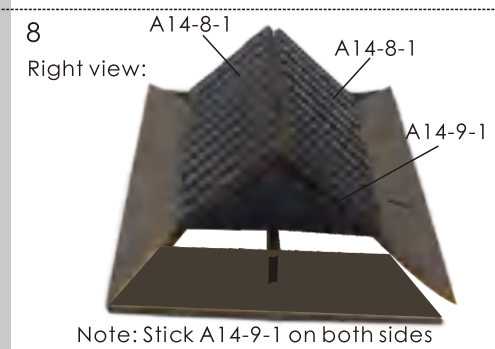
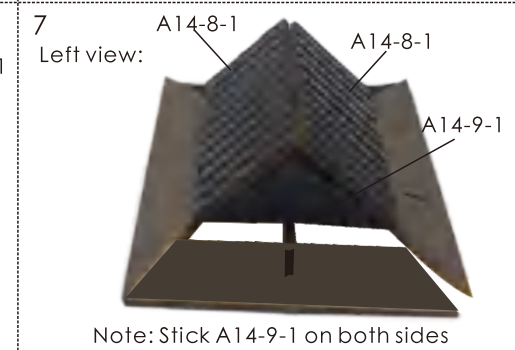
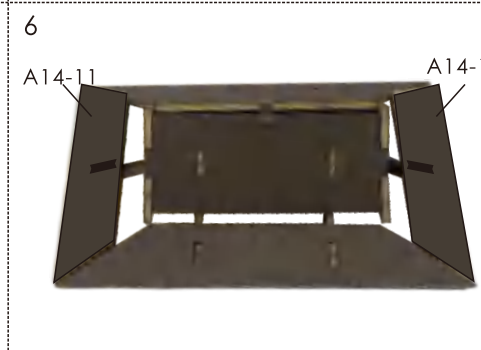
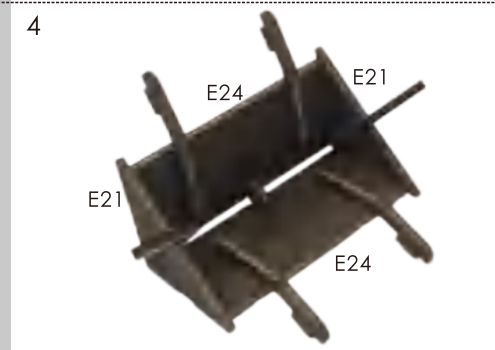
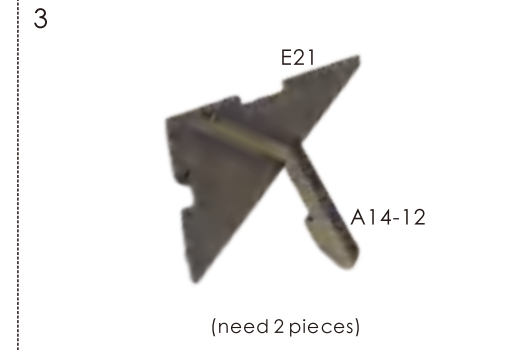
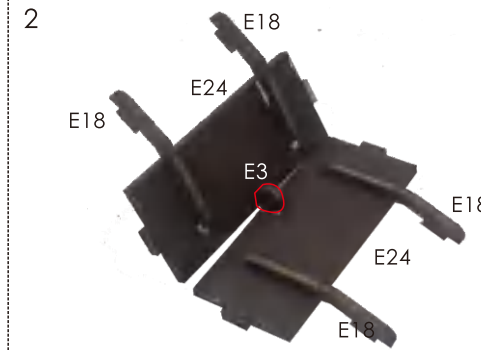
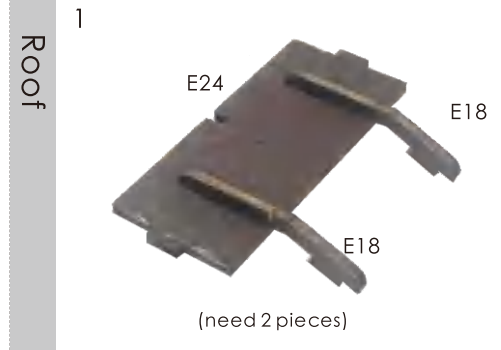
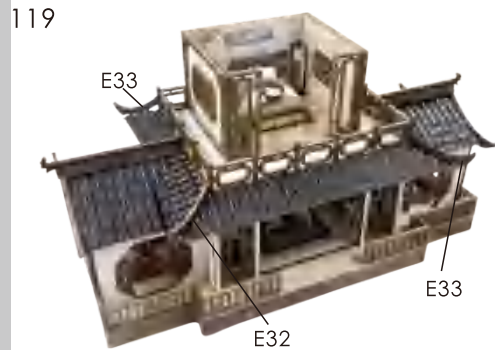
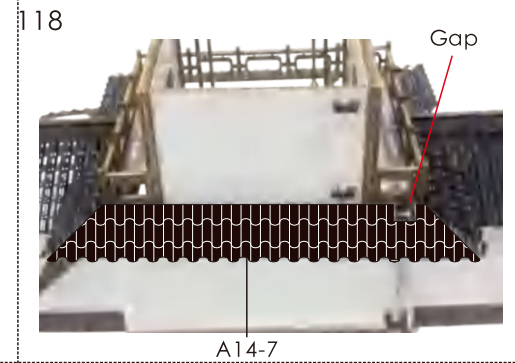
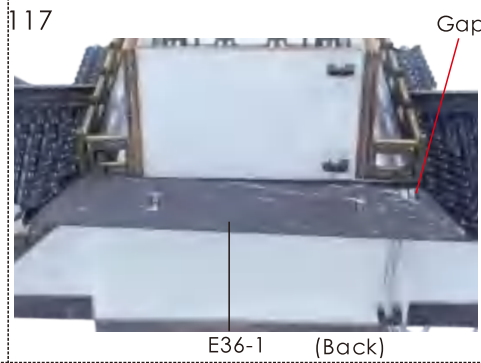
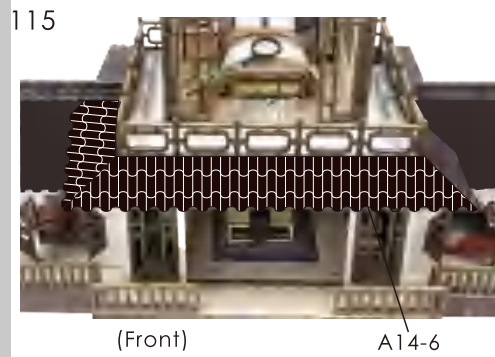

12

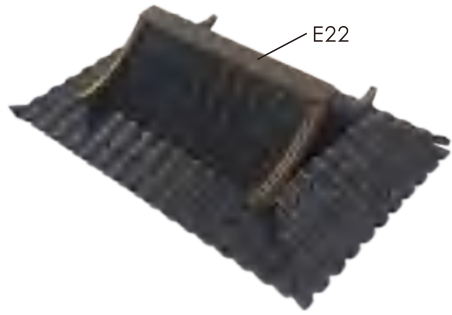

13

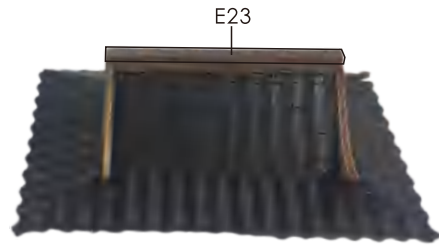

14



(Front)

15



(Back)

16

Small chandelier



17



(Back)

18



Lantern

(Front)

Lantern

19

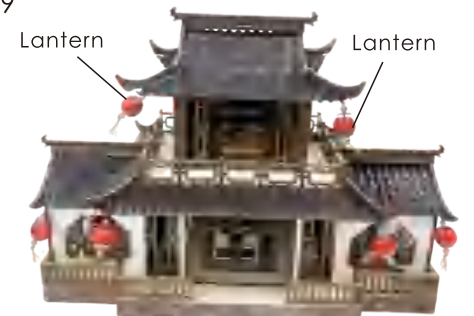

Lantern

Lantern

Wooden bridge

1

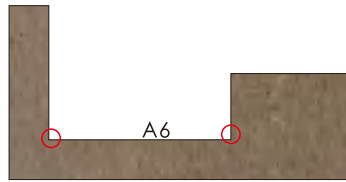

Cut the rounded corners within the red circle into right angles

2

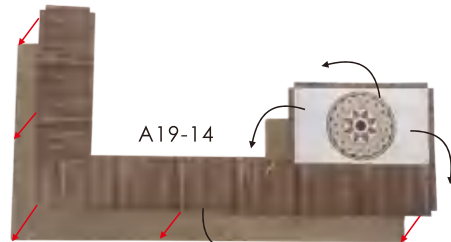

Wrap the edges well

3

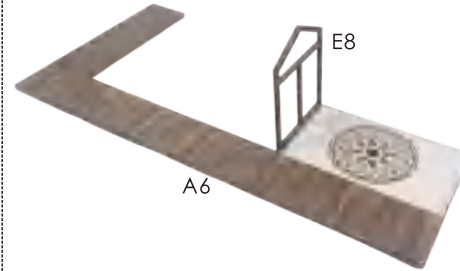

4

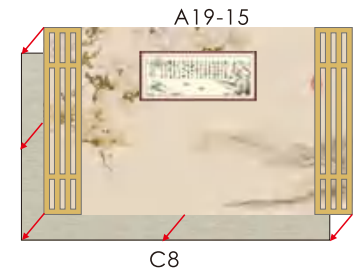

5

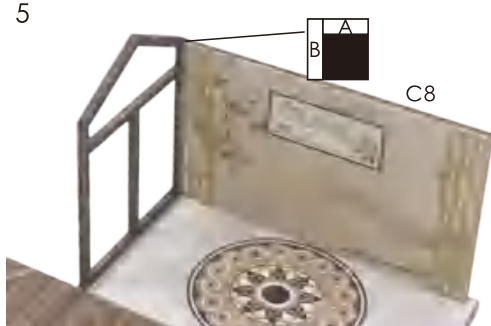

6

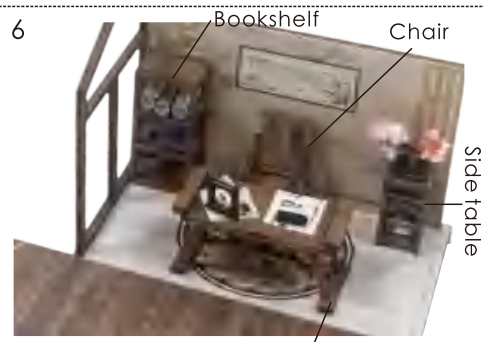

7

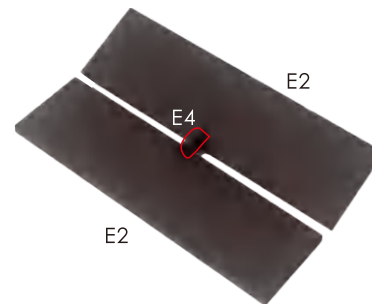

8

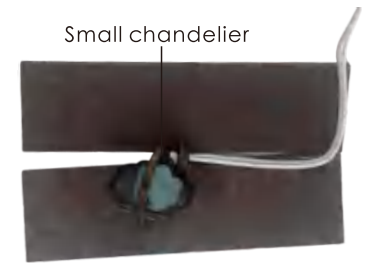

E2(Back)

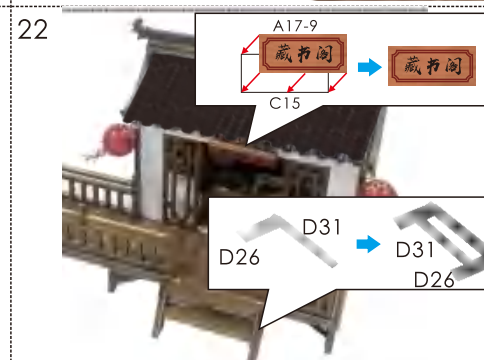
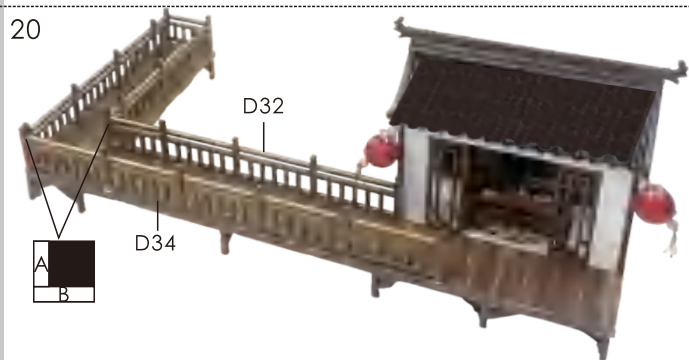
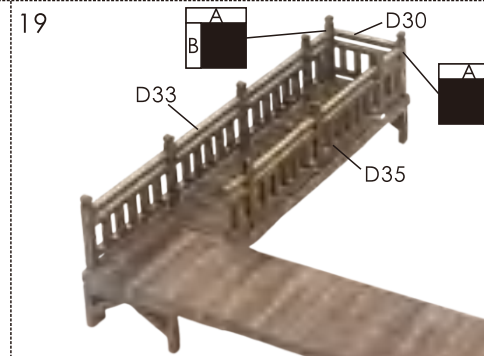
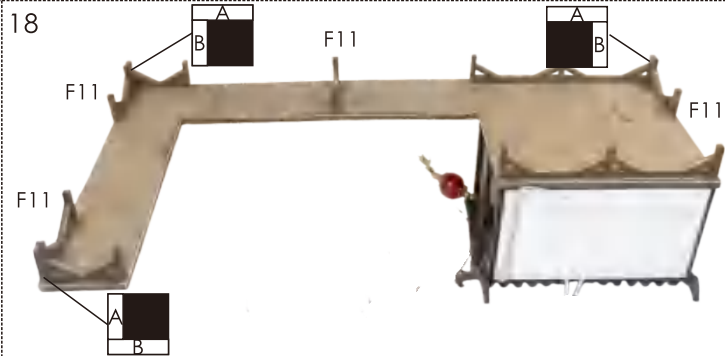
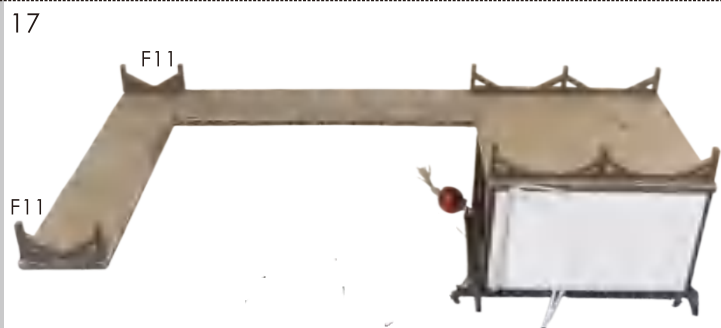
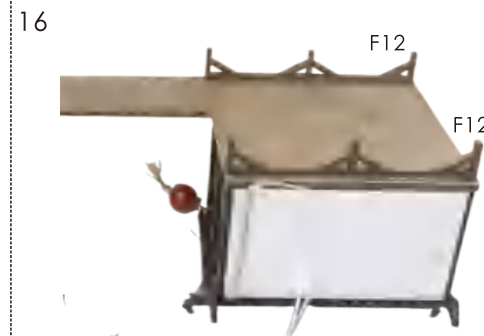
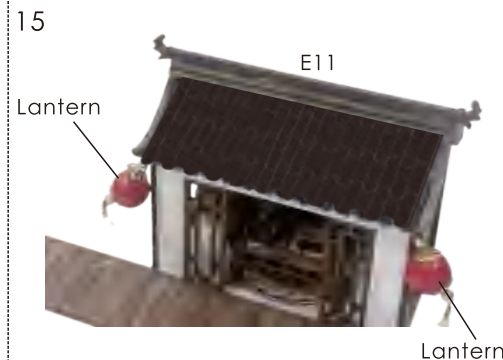
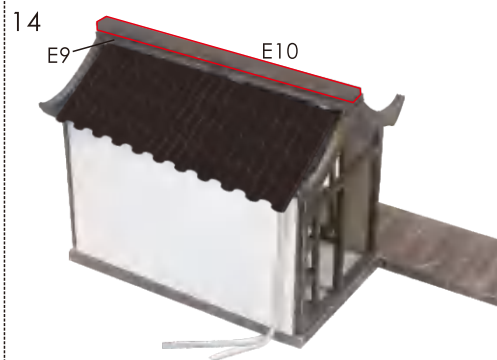
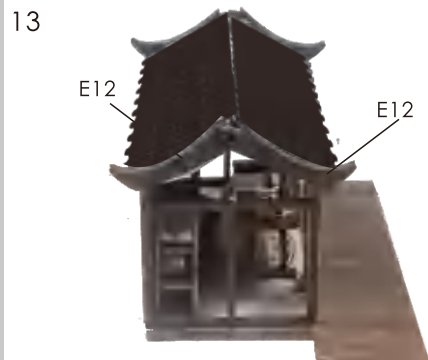
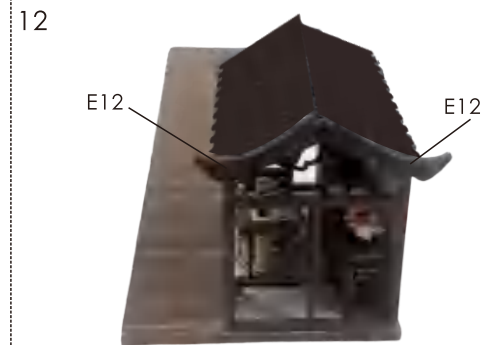
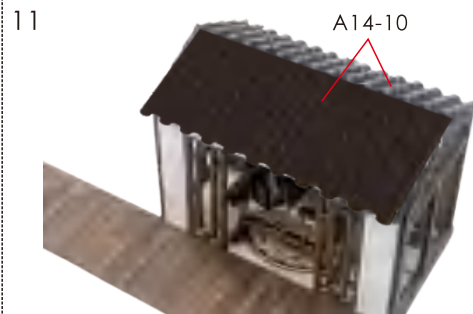

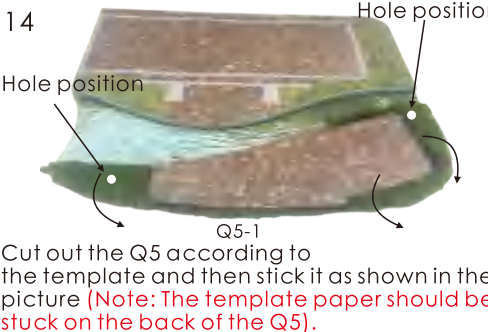
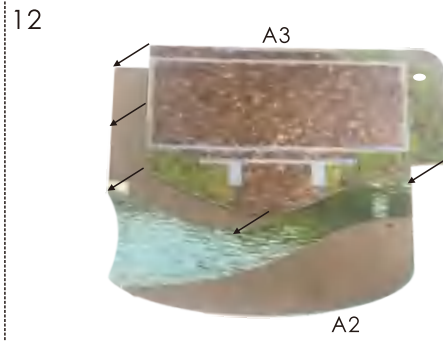
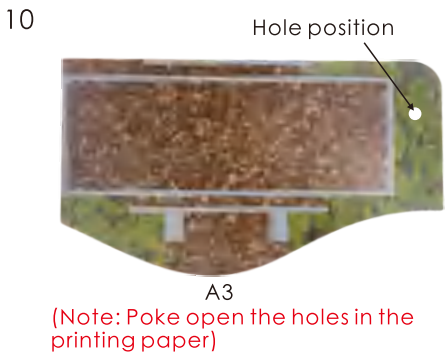
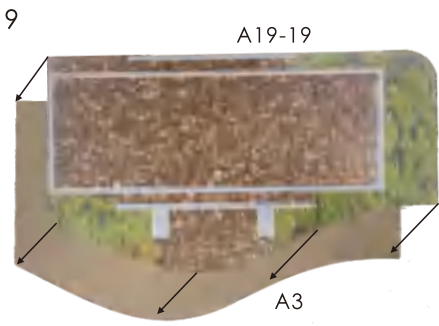
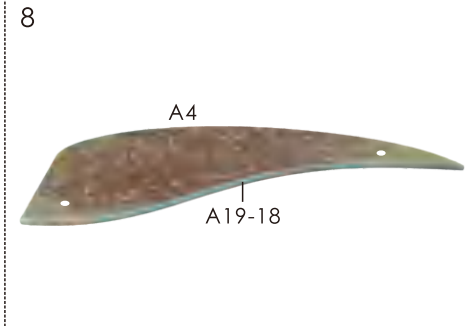
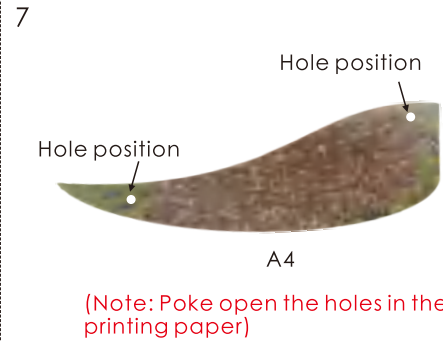
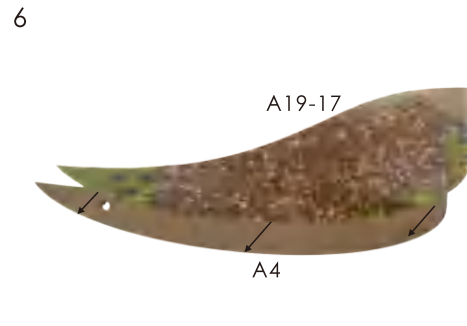
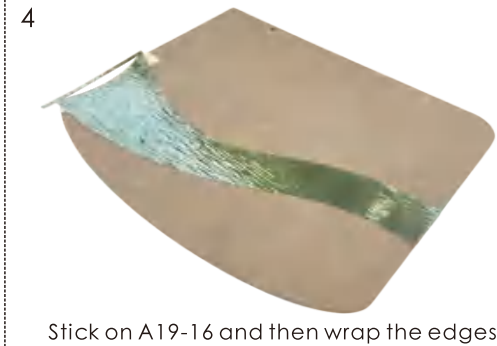
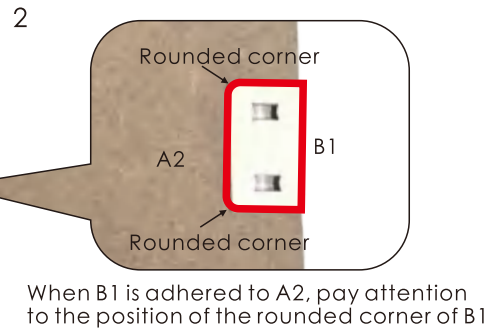
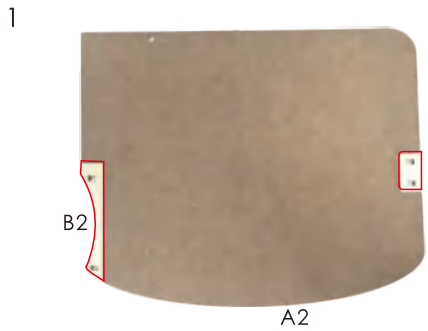

10



A19-26

Wrap the edges well

11

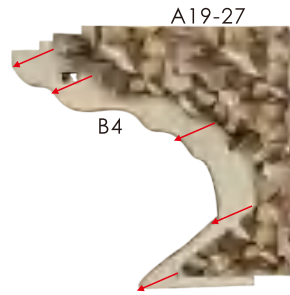

A19-27

B4

B4

12



13

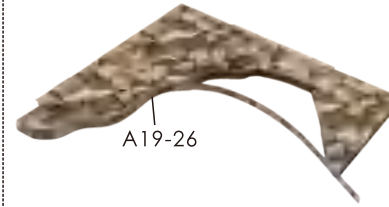

A19-26

14



B4(Front)

15

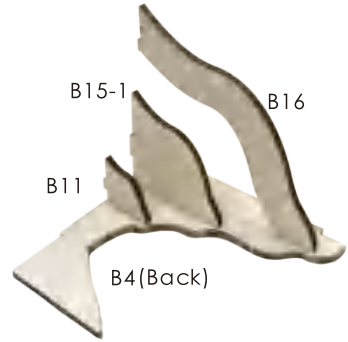

B15-1

B16

B11

B4(Back)

16



B7

17



B14

18



19

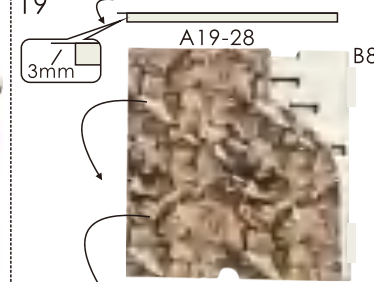

3mm

A19-28

B8

Wrap the edges well

20



B8

21

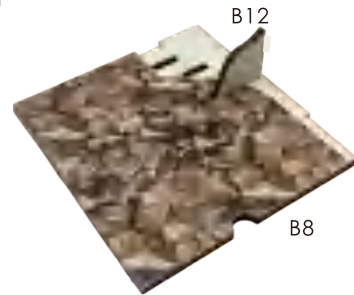

B12

B8

22



B15-2

23



B9

24

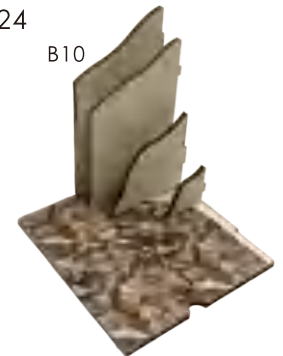

B10

25

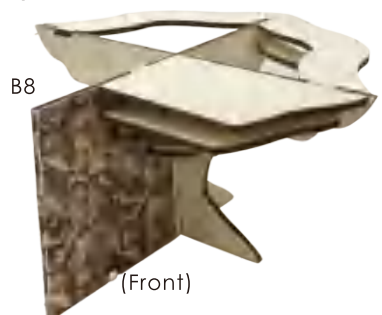

B8

(Front)

26

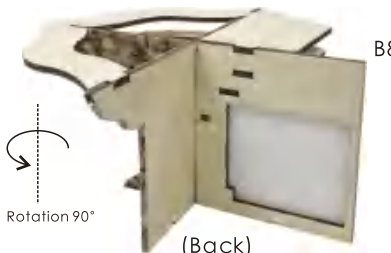

B8

(Back)

Rotation 90°

27



A8(Back)

A9

28



29



A7(Front)

<p>30</p>  <p>A19-29</p>	<p>31</p>  <p>(Front)</p>	<p>32</p>  <p>B6 A19-30</p>	<p>33</p> 	<p>34</p>  <p>A19-31</p>	<p>35</p>  <p>1</p>
<p>40</p>  <p>3</p>	<p>41</p>  <p>A19-34 B5</p> <p>Stick A19-34 in the same way to complete another B5</p> <p>4</p>	<p>36</p>  <p>A19-32 B6</p> <p>Stick A19-32 in the same way to complete another B6 way</p> <p>2</p>	<p>37</p>  <p>A19-33 B5</p>	<p>38</p> 	<p>39</p>  <p>A19-33</p>
<p>42</p>  <p>A19-35 B13</p>	<p>43</p>  <p>(need 2 pieces)</p> <p>5</p>	<p>44</p>  <p>3 1 5</p>	<p>45</p>  <p>2 4 5</p>	<p>46</p>  <p>3 1</p>	<p>47</p>  <p>2 4</p>
<p>47</p>  <p>2 4</p>	<p>48</p>  <p>A19-36</p> <p>(Back)</p>	<p>49</p>  <p>A19-37</p>	<p>50</p>  <p>A19-38</p>	<p>51</p>  <p>Rotation 90°</p> <p>A19-39</p>	<p>52</p>  <p>Rotation 90°</p> <p>A11</p>
<p>52</p>  <p>Rotation 90°</p> <p>A11</p>	<p>53</p>  <p>A10</p>	<p>54</p> 	<p>55</p>  <p>U1 U1 U1 B20</p> <p>As shown in the figure, stick U1 onto A2</p>	<p>56</p>  <p>B20 U1</p> <p>Stick B20 onto the wooden board and jam the wires</p>	<p>56</p>  <p>B20 U1</p> <p>Stick B20 onto the wooden board and jam the wires</p>

57



Q5-4

58



Q5-6

Q5-5

Cut out the Q5 according to the template and then stick it as shown in the picture (Note: The template paper should be stuck on the back of the Q5).

59

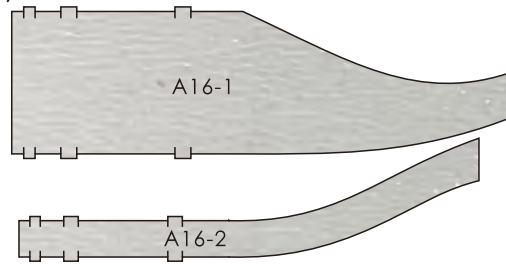

A16-1

A16-2

Cut out A16 according to the template

60

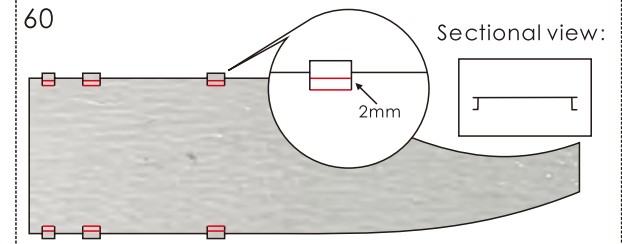

Sectional view:

2mm

Make a mark at the position of the red line on the drawing according to the dimensions on the drawing with a knife, and then fold it into a L shape

61



62



63

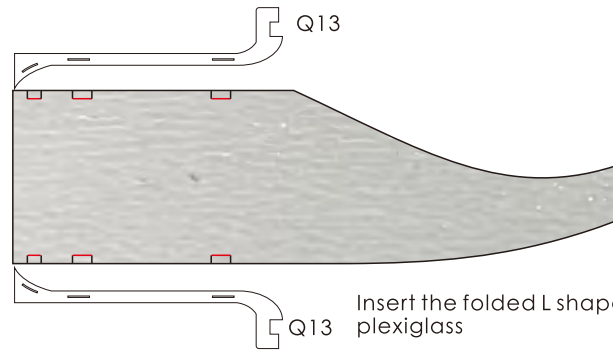

Q13

Q13

Insert the folded L shape into the plexiglass

64



A16-1

(Back)

65



(Front)

66

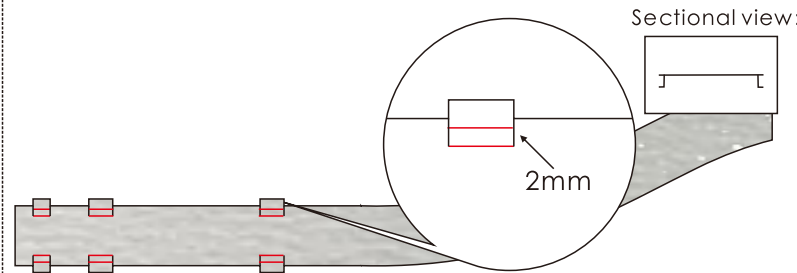

Sectional view:

2mm

67

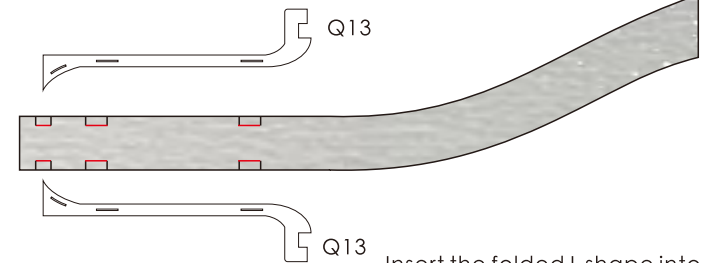

Q13

Q13

Insert the folded L shape into the plexiglass

68



A16-2

69

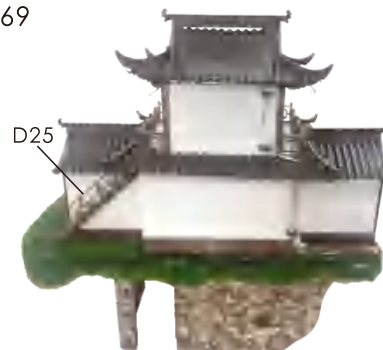

D25

70



Pass the light wire holes through the panel

71



(Front)

72



Concentrate the led light wires at the positions on the diagram

73



Stone lion

74

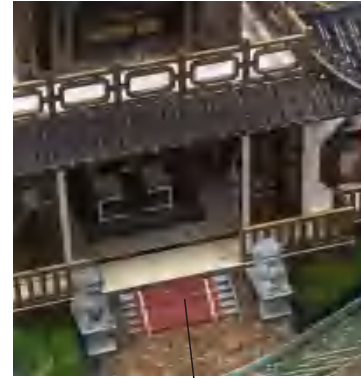

Steps

75



76



77



S10

Stick the stone S10 on according to your personal preference

78



S10

79 Pass the lamp wire through the hole



Outdoor lamp

80



81

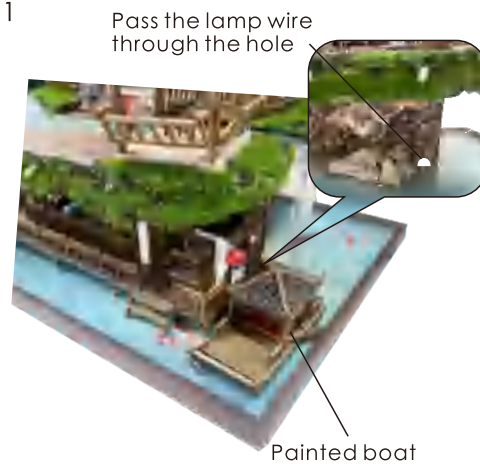

Pass the lamp wire through the hole

Painted boat

82



Waterwheel

83



S1

Insert the S1 into the holes on the panel

84



85



86



87



88

Little bridge



89

Steps



90

S2



Insert the S2 into the holes on the panel

91

A17-21



92

A17-21



93

(need 6 pieces)
A17-22



As shown in the picture, stack 2 pieces of A17-21 and 2 pieces of A17-22 together

94

A17-23

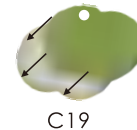

C19

95

C19



96

(need 3 pieces)
S5



C19

97



A17-25 A17-24

98



A17-25 A17-24

Stick the flowers on according to your personal preference

99

S8

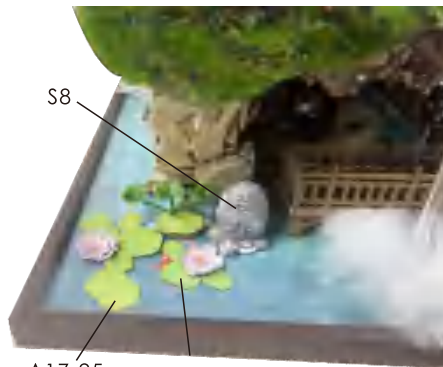

A17-25 A17-24

100



A17-25 A17-24

Disclaimer: This wire cannot be plugged into the output socket

- LED lights before use, should can test the light
- Can use two AAA batteries
- The positive and negative poles of the battery are aligned and the battery is installed
- Non-rechargeable batteries, cannot be charged
- Rechargeable batteries can only be charged under adult supervision
- Rechargeable batteries should be removed from the toy before charging
- Different types of batteries or old and new batteries cannot be mixed
- Batteries should be inserted with correct polarity
- Exhausted batteries should be removed from the toy
- The power terminal must not be short-circuited

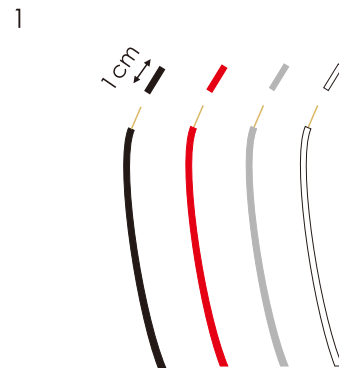

1 Peel off 1 cm of rubber from the heads of all wires

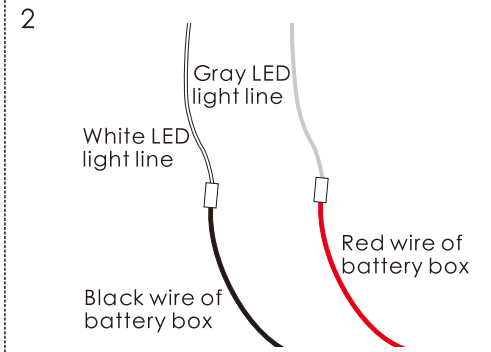

2 Connect the Black and LED white wires of the battery box, as well as the red and gray LED gray wires of the battery box, respectively



3 Wrap the threads of the same color together



4 Connect the battery box



5 Wrap the exposed copper wire with U3



Installation of dust cover

Dust cover (Upgrade version accessories need to be purchased separately)



Z1 plexiglass (transparent)
31*23*0.18cm
(1 Piece)



Z2 plexiglass (transparent)
31*25*0.18cm
(2 Pieces)



Z3 plexiglass (transparent)
25*22.64*0.18cm
(2 Pieces)

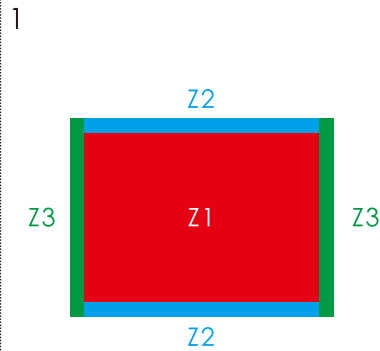

Stick Z1 and Z2 on Z3

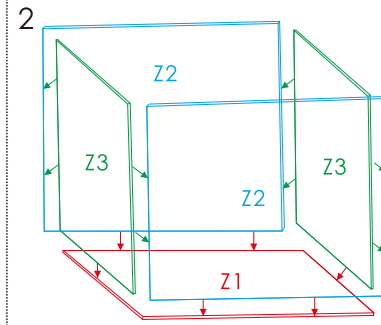

stick five pieces of plexiglass dust cover as shown



Ripped one side of kraft paper, leaving one side of kraft paper

Take out the plexiglass and tear off the kraft paper with text on each piece of plexiglass.

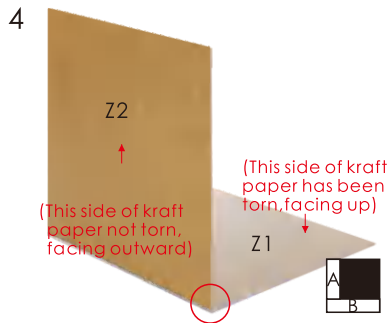

Torn side of the kraft paper faces inward, untorn side faces outward.

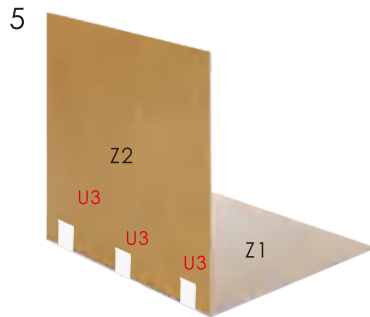

Use U3 to secure the acrylic joint (or substitute with transparent tape).

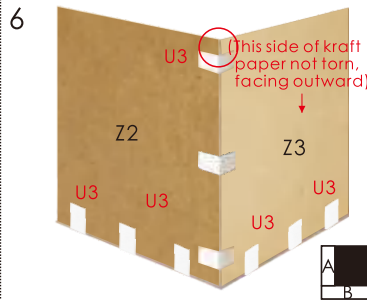

Each joint between the acrylic sheets needs to be secured with U3 (to prevent the sheets from falling).

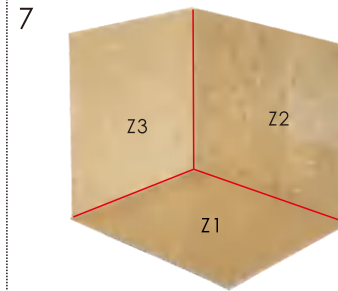

Apply glue to the glass joint and scrape lightly for penetration (red line indicates the joint).

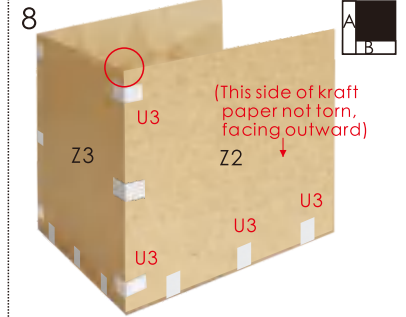

The junction of two pieces of plexiglass needs to be fixed with U3 (to prevent the plexiglass falling off)

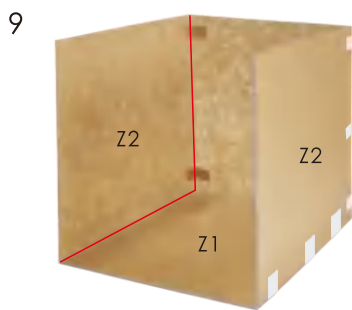

Apply glue to the interface between the two glass pieces and gently scrape to ensure the glue penetrates the joint (red line indicates the acrylic joint).

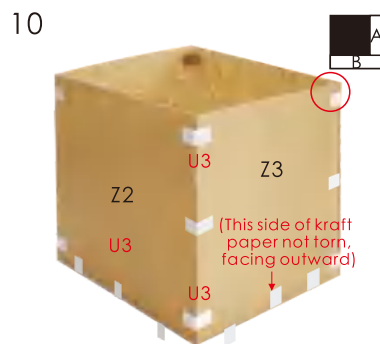

The junction of two pieces of plexiglass needs to be fixed with U3 (to prevent the plexiglass falling off)

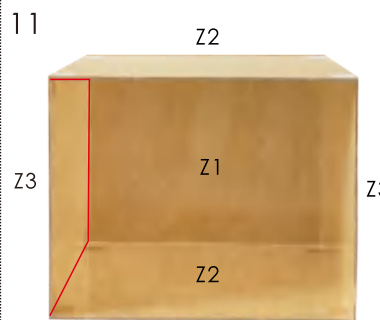

Apply glue to the interface between the two glass pieces and gently scrape to ensure the glue penetrates the joint (red line indicates the acrylic joint).

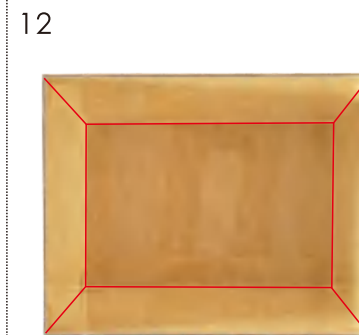

The dust cover needs to be glued at 8 interfaces.



Leave it for 1 hour. After the glue dries out, tear off a layer of kraft paper outside the plexiglass.

Detail drawing





The instruction manual should be keep, after assembled.